



*Drainage systems and components for sports facilities,  
playing areas and leisure facilities*

**ACO SPORT® – The full range**

## Welcome to ACO SPORT®

*It goes without saying that open-air spaces are exposed to the elements, with water being a key culprit. For sports facilities, this poses two problems: safety during competitions and long-term preservation of the venues. ACO SPORT® covers drainage systems and components for sports facilities, playing fields and leisure facilities, thus helping to ensure that they are safe, suitable for play and of an appropriate standard to host competitions.*

### Contents

<b>Athletics facilities</b>	<b>3</b>
<b>Running track drainage</b>	<b>4</b>
Type A arena	6
Type B arena	8
Type C arena	10
Type D arena	16
<b>Area drainage</b>	<b>18</b>
Surface drainage to suit the sports surface...	20
...in stadiums and on football pitches	21
...on hockey pitches	22
...on small sports areas, all-weather pitches and contemporary sports facilities	23
Channel systems for covered areas	24
Slot channels for non-covered areas	25
<b>ACO Sport products...</b>	<b>26</b>
<b>... for track drainage</b>	<b>28</b>
Box channel (as a hidden channel)	28
Slot channel (as a hollow-profile channel)	30
Trough channel (open channel)	33
<b>... for running tracks, playing fields and sports facilities</b>	<b>34</b>
Elastic kerbstones	34
Sand capture channel	35
Surrounding slab	36
Surrounding kerb	37
Cable distribution shaft	37
<b>... for area drainage</b>	<b>38</b>
Trough channel for rectangular playing areas	38
Trough channel for rectangular playing areas with artificial turf clamping	39
Point drainage	40
Stainless-steel and hot-dip galvanised steel channels	42
<b>Service</b>	<b>44</b>
Material information	46
Arena requirements	47
Installation plans	48
Hydraulics	54
Certificates	58
General	59

## Athletics facilities

The DIN 18035 standard distinguishes between four categories of sports facilities and arenas on a national level depending on their respective requirements and equipment:

Athletics facilities of types A to C comprise a large, rectangular playing area with two semicircles at each end, which are also referred to as sectors or segments. Each of these sectors contains individual equipment for the respective

disciplines. The facility is surrounded by a 400 m running track, which is made up of two straight sections running in parallel and two arced sections, each with the same radius. The longitudinal axis of the facility is aligned from north to south.



**Type A arena**

International athletics competitions and high-profile national events may only be held at type A arenas in accordance with IAAF guidelines.



**Type B arena**

Regional championships and supra-local events are held at type B arenas in accordance with international competition rules and the German Athletics Association (DLV). These facilities generally also comply with the training requirements for elite sport.



**Type C arena**

Type C arenas are generally used for school sports and non-elite athletics events.

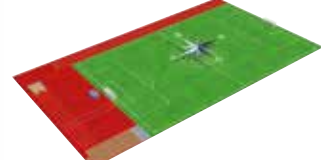

**Type D arena**

School sports and wider, grass-roots activities can also make use of the combination of facilities found in type D arenas, which do not have a running track, but have a playing area with individual athletics equipment.

Whether it's just been raining or in the middle of a shower, playing fields and sports facilities have to be back in good shape as quickly as possible for athletes to be able to use them. Channel elements for collecting and removing surface water have proven a valuable resource for

decades when it comes to comprehensive surface drainage. ACO SPORT® channel systems ensure that the playing areas in a variety of sports facilities remain functional whilst also promoting long-term preservation.

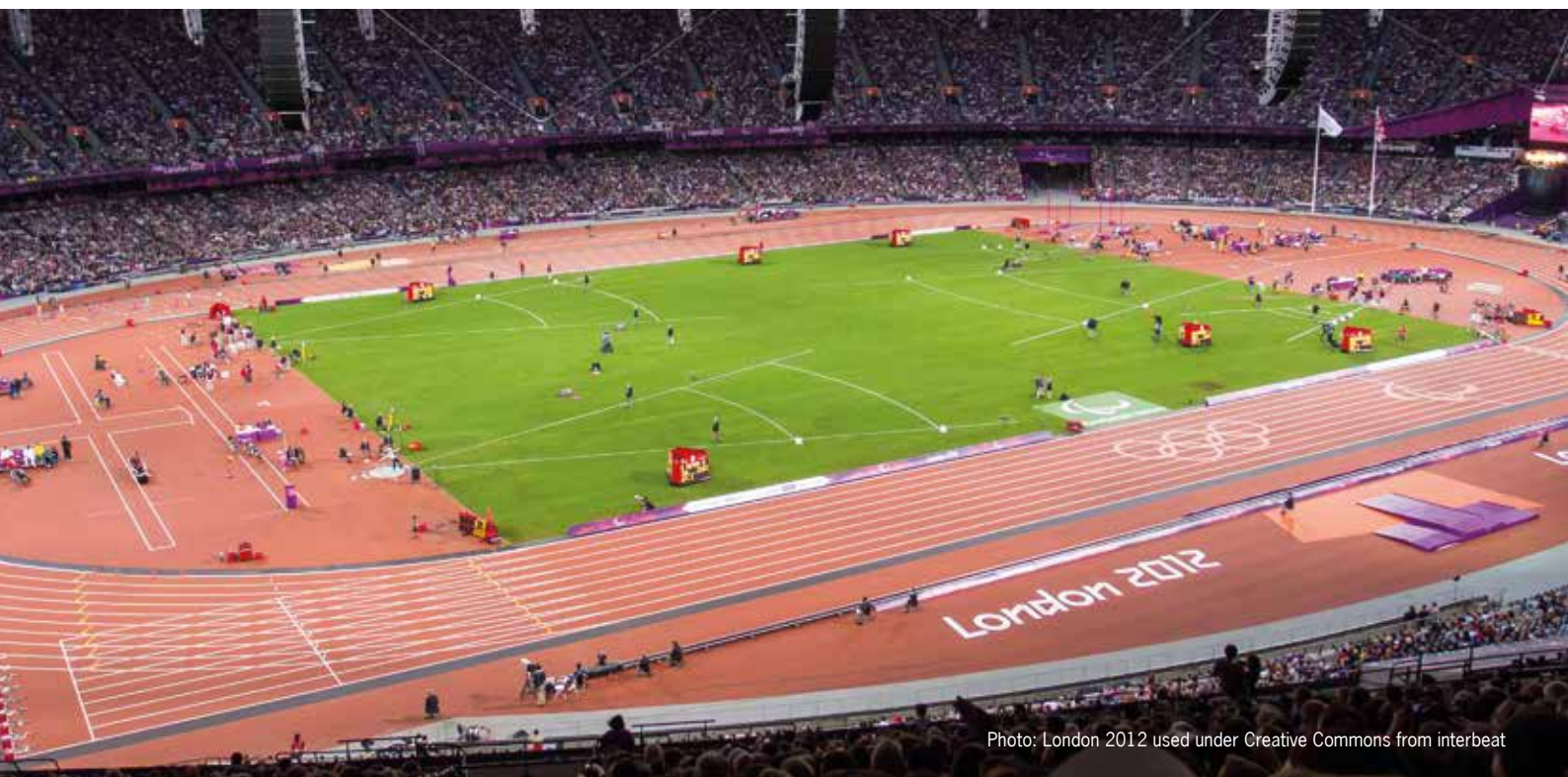

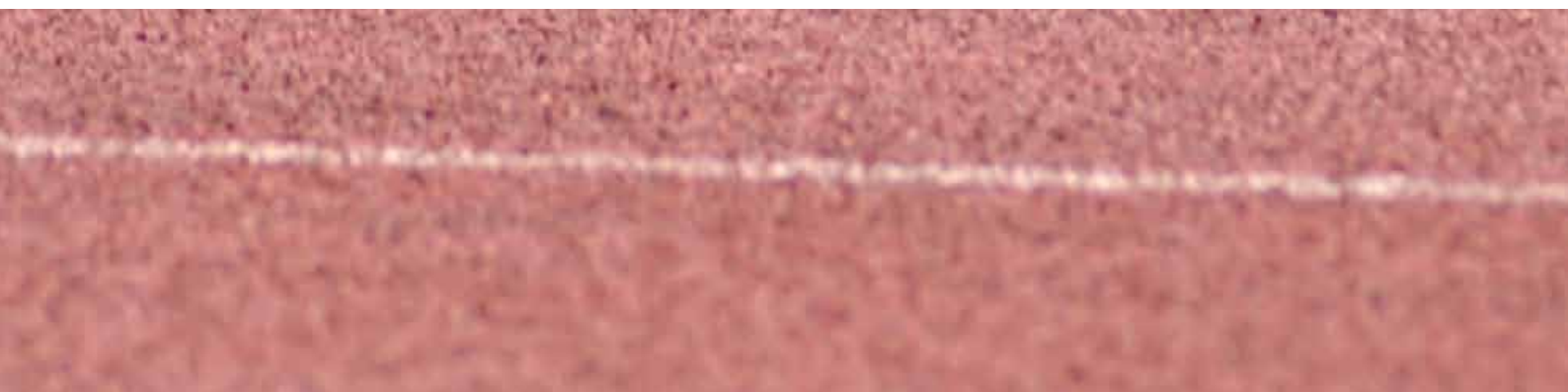



## Track drainage

ACO SPORT® drainage systems for running tracks not only offer a drainage facility, but also provide the necessary perimeter around the edge of the track, making them an ideal combination. The 5 cm high covers, which can be stationary or mobile, comply with IAAF guidelines and national standards for inner track surrounds. Aligned with the surface contours on the inside of the track, the channel trains collect surface water and demarcate the running track from the playing field and the sector surfaces thanks to the raised covers.



### Type A arena

Type A arenas are no longer used simply for athletics events or ball games, they even play host to large-scale functions and events. All playing fields and sports facilities are set up at the same level to provide a seamless transition from the running track and the synthetic sectors to the playing field. The use of ACO SPORT® NW 125 slot channel systems with various hollow-profile channels ensures that all types of sport can be played at these single-level facilities with no limitations.

To be eligible to host races over 200 m, the running track must be demarcated with an inner kerb in accordance with international competition rules. At 5 cm high and 5 cm wide, this inner kerb should be made of materials which are easy to handle so that they can be removed with ease on a temporary basis during field events. With this in mind, the blind plastic covers from ACO can be moved and detached, making them the ideal choice.



**Slot channel clear width 125  
plastic cover can be  
layered over on one side, moved  
and detached**  
Page 30, 31

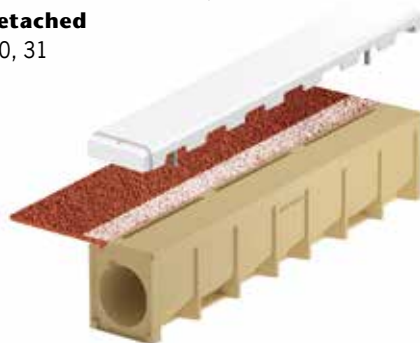

**Slot channel clear width 125  
plastic cover can be  
layered over, moved  
and detached**  
Page 30, 31

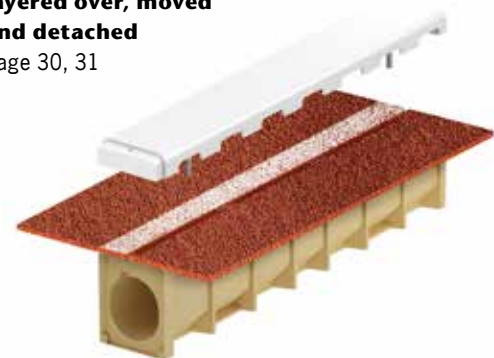



**Sport surrounding kerb**  
Page 37



**Sand capture channel**  
Page 35



**Elastic kerbstones**  
Page 34



**Cable distribution shaft**  
Page 37



**Inlet shaft for slot channel and inspection box**  
Page 31



### Type B arena

Type B sports facilities are not only used for athletics, but primarily for football or other ball games. To make sure the playing conditions are safe for all users, particularly due to the 5 cm high border required around the running track, the large playing area is also built 5 cm above the level of the running track. This means the border edge can be permanently installed on the raised edge of the playing field directly, by means of a hidden channel construction, thus presenting no ob-

stacle to step over. The sectors designed as artificial surfaces for athletics competitions run flush with the level of the running track at the prescribed surface gradient.

The ACO SPORT® NW 125 drainage system is a combination of hidden channels and hollow-profile channels. The system intelligently unites fast surface drainage of the sporting surfaces and the particular requirements of all users of modern

sports facilities. For example, if there is a raised playing field, the drainage is routed through hidden channels designed as box channels with a stationary stable cover, which also serves as the 5 cm high border around the running track. The channels are raised above the side of the playing field via a 4 cm high cast-on turf support. Water enters from the running track at the side, through the supported plastic cover with its inlet slots that conform to standard.



**Hidden box channel**  
Page 28, 29



**Inlet shaft for box channel**  
Page 28





The sectors are drained via integrated hollow-profile channels, which are layered over with a synthetic surface in situ. The plastic cover and its mobile elements are plugged into the slots arranged above the running track in order to create the required border around it. This border can be dismantled quickly, which means the sectors can be accessed easily from the running track, thus ensuring technical discipline as regards athletics.



**Sport surrounding kerb**  
Page 37



**Cable distribution shaft**  
Page 37



**Sand capture channel**  
Page 35



**Elastic kerbstones**  
Page 34



**Inlet shaft for slot channel and inspection box**  
Page 31



**Slot channel clear width 125 plastic cover can be layered over, moved and detached**  
Page 30, 31

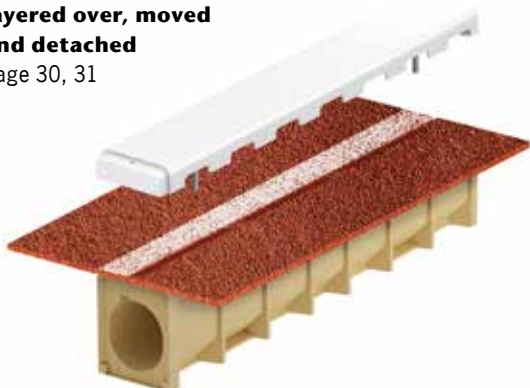

**Type C arena with synthetic running track**  
**Raised playing field**

Type C sports facilities are designed for school sports and wider, grass-roots facilities, whilst also providing an essential venue for regional-level football.

To comply with regulations for races held on synthetic tracks, particularly due to the 5 cm high border required around the running track, the football pitch is also built 5 cm above the level of the running track. This means the border edge can be permanently installed on the raised edge of the playing field directly, by means of a hidden channel construction, thus presenting no obstacle to step over. The sectors in type C facilities run flush

with the level of the running track at the appropriate gradient and often have a synthetic surface. As a result, sports surfaces for technical disciplines or multi-functional fields for a range of ball sports can be created in these sectors. The ACO SPORT® NW 125 drainage system is a combination of hidden channels and hollow-profile channels. The system intelligently unites fast surface drainage of the sporting surfaces and the particular requirements of all users of modern sports facilities. For example, if there is a raised playing field, the drainage is routed through hidden channels designed as

box channels with a stationary stable cover, which also serves as the 5 cm high border around the running track. The channels are raised above the side of the playing field via a 4 cm high cast-on turf support. Water enters from the running track at the side, through the supported plastic cover with its inlet slots that conform to standard.

In the sector area, the track can be drained via hidden box channels without cast-on turf supports and, in some sections, via hollow-profile channels as compact slot channels, which are layered



**Hidden box channel**  
 Page 28, 29



**Inlet shaft for box channel**  
 Page 28



over with a synthetic surface while in situ. The installation of slot channels facilitates the transitions from the running track to the interior sports surfaces and playing fields. And to create the required border around the track, the mobile plastic cover can be plugged into the slots and quickly removed again to establish these transitions.



**Sport surrounding kerb**  
Page 37



**Cable distribution shaft**  
Page 37



**Sand capture channel**  
Page 35



**Elastic kerbstones**  
Page 34



**Inlet shaft for slot channel**  
Page 31

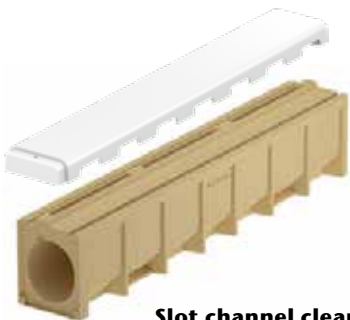

**Slot channel clear width 125  
blind plastic cover can be  
layered on both sides and  
moved**  
Page 30, 32

**Example of a type C arena with synthetic running track  
Level facility**

Type C arenas are not required to have the 5 cm border around the track as stipulated by competition rules, as they do not host official race meetings (such as armed forces facilities).  
The playing fields and sports surfaces should, however, all be level to ensure a

seamless transition between these areas and the synthetic training track.  
With its various hollow-profile channels, the ACO SPORT® NW 125 slot channel system ensures that these sports facilities can be used with no limitations. The compact, hollow-profile channels in poly-

mer concrete are the products of choice in many sports facilities associated with public security institutions, which have counted on the robust design and stability of this type of track drainage system for years.



**Slot channel clear width 125  
can be layered over  
on one side**  
Page 30



**Plastic cover can be moved  
and detached if necessary  
for slot channels**  
Page 32



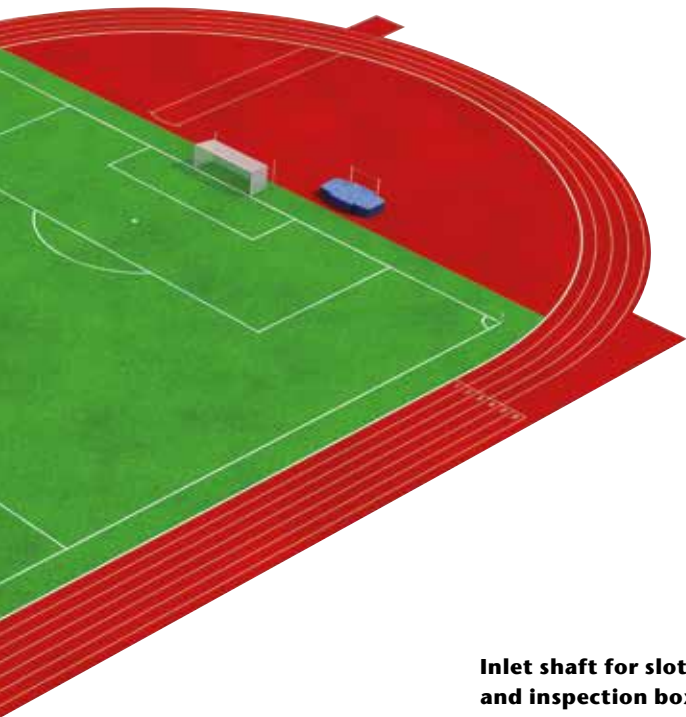

**Surrounding slab**  
Page 36



**Cable distribution shaft**  
Page 37



**Elastic kerbstones**  
Page 34

**Inlet shaft for slot channel  
and inspection box**  
Page 31



**Slot channel clear width 125  
can be layered over on both  
sides**  
Page 30



## Type C arena with cinder running track

Type C arenas with cinder running tracks are primarily used as football fields with a running track around the outside for use by schools. They are not used for official athletics competitions as there is no border around the running track. The playing field and sectors – whether grass or cinder – lie flush with the running track.

Any surface water that collects on these single-level playing fields and sports surfaces can be drained with the ACO SPORT® trough channel drainage system, which comprises open channels in line with DIN 18035 Part 3. Only trough channels with a trough depth which complies with this standard may be used for

open channels. As they are so easy to clean, trough channels are particularly suitable for cinder sports surfaces, artificial turf filled with a granulate mixture, or natural turf.



**Trough channel**  
Page 33



In sections of facilities with a cinder surface, it is even possible to install individual gullies with a pipe connection for drainage at certain individual locations.

**Inlet points**  
Page 40

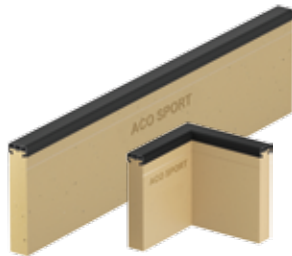

**Elastic kerbstones**  
Page 34



**Inlet shaft**  
Page 33

**Type D combination facility**

Type D arenas are primarily used by schools, although they are often available for wider, grass-roots sports. In accordance with DIN 18035, these sports facilities comprise a large playing area, an adjoining, synthetic short-distance track, and sports surfaces for field events at one end. All sports surfaces are at the same level. As the facility does not have a circular running track, there is no need for a raised border around the edge.

Any surface water can be drained away with ease thanks to the ACO SPORT® trough channel drainage system, which comprises open channels in line with DIN 18035 Part 3. Only trough channels with a trough depth which complies with this standard may be used for open channels.

For synthetic sports surfaces, such as running tracks, trough channels with groove are recommended. The 5 cm wide markings can be made on the extension down one side. And for surface drainage of paved areas, the trough channel without groove is another particularly suitable choice thanks to its robust, easy-to-clean design.

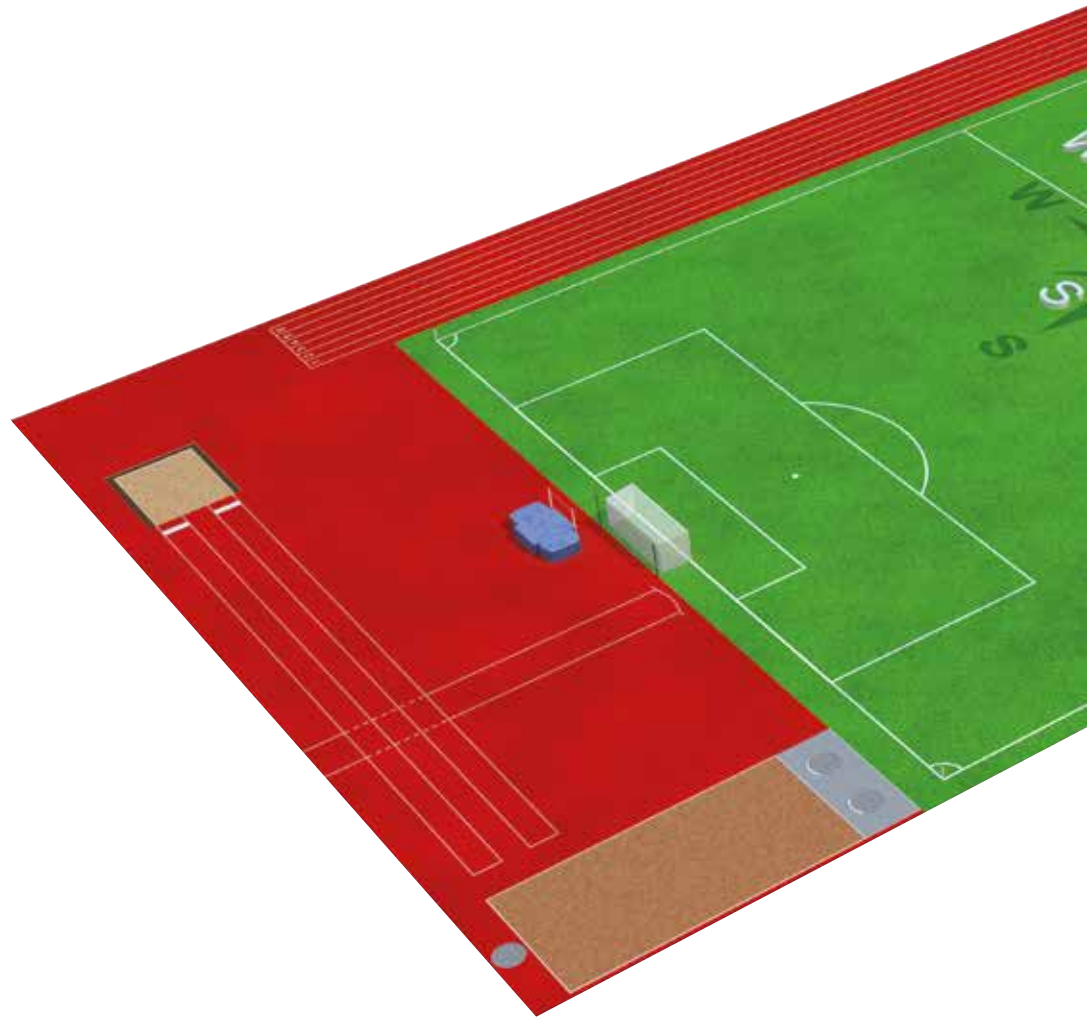

**Trough channel with groove**  
Page 33



**Inlet shaft**  
Page 33





**Surrounding kerb  
for artificial surfaces**  
Page 37



**Sand capture  
channel**  
Page 35

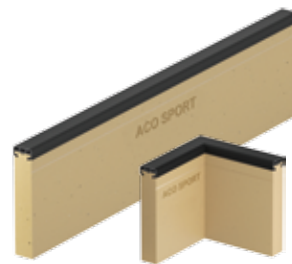

**Elastic kerbstones**  
Page 34



**Inlet shaft**  
Page 38



**Trough channel for  
rectangular playing areas**  
Page 38



An aerial photograph of a large, modern stadium at night. The stadium is illuminated with bright lights, and its distinctive white, lattice-like structure is visible. The interior is filled with spectators, and the field is lit up. In the background, a dense city skyline is visible under a clear blue sky. The stadium is surrounded by greenery and parking areas with many cars.

## Area drainage

ACO SPORT® surface drainage systems protect and preserve sports facilities and venues for anything from ball games to more contemporary sports. Whether it's for covered or non-covered areas of the stadium, or even for draining small sports areas, different installation situations call for different systems. It is also important to consider the types of coverings and sports surfaces when selecting the drainage system.

### Surface drainage to suit the sports surface ...

The conventional covering for large pitches is generally either natural turf or cinder. That said, artificial turf has been gaining in popularity for decades as it is more likely to be playable whatever the weather.

With the exception of the odd tennis court, modern athletics facilities and small sports areas are generally based around a flexible artificial surface. After all, only flexible artificial surfaces have the properties required to live up to any

sporting requirements.

Even artificial turf boasts this level of flexibility. A distinction can be made between surfaces with a **pile-filled layer**, which is an artificial turf filled with a mixture of sand and rubber crumb, or sand and cork, and the classic artificial turf with an **unfilled pile layer** – the traditional artificial turf surface laid on top of a flexible layer. While pile-filled artificial turf has a high net weight due to the addition of the filling material, unfilled,

traditional artificial turf should be secured with clamping rails at the edges. All surface requirements for outdoor sports facilities are stipulated in DIN 18035 Part 4-7.

These surfaces are generally permeable; however, for the protection of the athletes, surfaces and the entire facility, it is always recommended to install a functioning surface drainage system, particularly to cope with heavy rainfall.

### Football stadiums and pitches

Page 21



Hockey pitches

Page 22



Small sports areas, all-weather pitches and contemporary sports facilities

Page 23



Trough channel for natural turf



Trough channel for filled-pile artificial turf

**... in stadiums and on football pitches**

Generally speaking, the playing field in football stadiums is made of natural turf. That said, many sports facilities are turning to filled artificial surfaces to ensure they can be used for a wider variety of activities and remain playable for a longer period of time. The filling material is a granulate mixture of either sand and rubber crumb, or sand and cork. Both ar-

tificial turf and natural turf surfaces are permeable. To drain surface water not only from the sports surface itself, but also from the surrounding areas at the same level, the ACO SPORT® trough channel drainage system has proven itself to be the solution of choice. The low trough depth of 15 mm, which complies with DIN 18035,

ensures safety and trouble-free water drainage, whilst also allowing granulate to be swept away quickly. It is even possible to pave directly over the vertical side walls for the symmetrical trough.



**Trough channel for rectangular playing areas**  
Page 38



**Inlet shaft**  
Page 38

**... on hockey pitches**

Hockey is played on artificial, unfilled turf with a short, dense pile which requires watering. For decades now, the professional game has been played on this type of artificial surface outdoors rather than on natural turf. The quality of the “grass” and the uniformity of the surface has made the game significantly faster, more accurate and more dynamic. Traditional artificial turfs which do not

have a filled pile layer, and the flexible, underlying base layer are both permeable. The ACO SPORT® trough channel drainage system allows excess surface water to be drained away quickly – including from the surrounding surfaces. Safety is ensured thanks to the low trough depth of 15 mm, which complies with DIN 18035. A clamping rail is recommended to secure the conventional, unfilled artifi-

cial turf to the edges of the playing field, while the trough channel can be plastered in directly along the vertical side walls. The product range is rounded off by a kerbstone with a clamping device for the artificial surface.



es, small sports areas, tennis courts, volleyball courts and fun park areas to drain off surface water quickly.



**Trough channel with clamping rail**

Page 39



**Inlet shaft with clamping rail**

Page 39

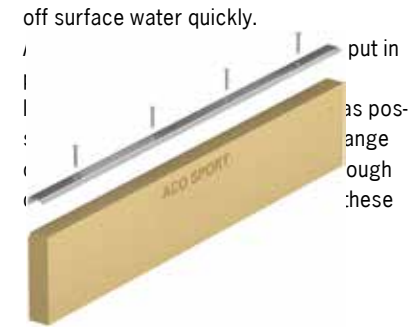

**Clamping block with clamping rail**

Page 39

... on small sports areas, all-weather pitches and contemporary sports facil-

ities. As a broad yet compact component, which is firmly anchored to the sub-structure, the trough is secure, stable and self-cleaning with an anti-vandal surface.

And to promote long-term maintenance of synthetic sports surfaces, it provides an ideal perimeter against the surrounding areas of vegetation or paving thanks to sport surrounding slabs or kerbs with

nuts for interlocking grooves.

Acting as a perimeter for sports fields and other associated facilities, ACO SPORT® elastic kerbstones ensure safety whilst also reducing the risk of accidents. For drainage at certain individual locations around sports facilities with a hard surface, stainless-steel point drainage systems with a safe, stable and secure cover are recommended.

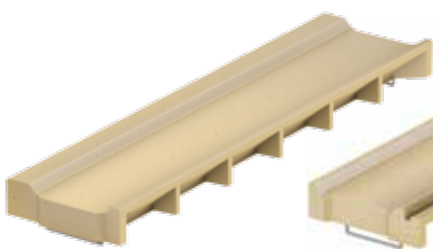

**Trough channel**  
Page 33



**Trough channel with groove**  
Page 33



**Inlet shaft for trough channel**  
Page 33

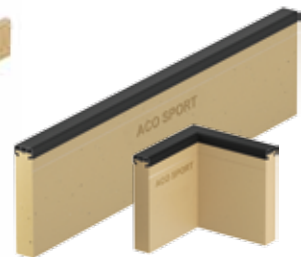

**Elastic kerbstones**  
Page 34



**Surrounding slab**  
Page 36



**Surrounding kerb**  
Page 37



**Point drainage**  
Page 41



### Stainless-steel channel systems for covered areas



It is an absolute necessity for stadiums to have facilities in place to drain rainwater away from sealed surfaces such as entrances, external walkways and bridges immediately for the protection of spectators and facilities alike. In covered areas with low structure heights in particular, custom-made, stainless-steel channels systems are a reliable, trusted and cost-effective solution. The drainage system is specially designed for the building in question and tailored to suit the individual facility.





### Hot-dip galvanised slot channels for non-covered areas

For drainage in tiered facilities, robust, galvanised-steel slot channels are the recommended choice. The asymmetrical design of the slot channel offers a discreet drainage solution directly between the step and the plaster.



**Steel slot channel**  
Page 43





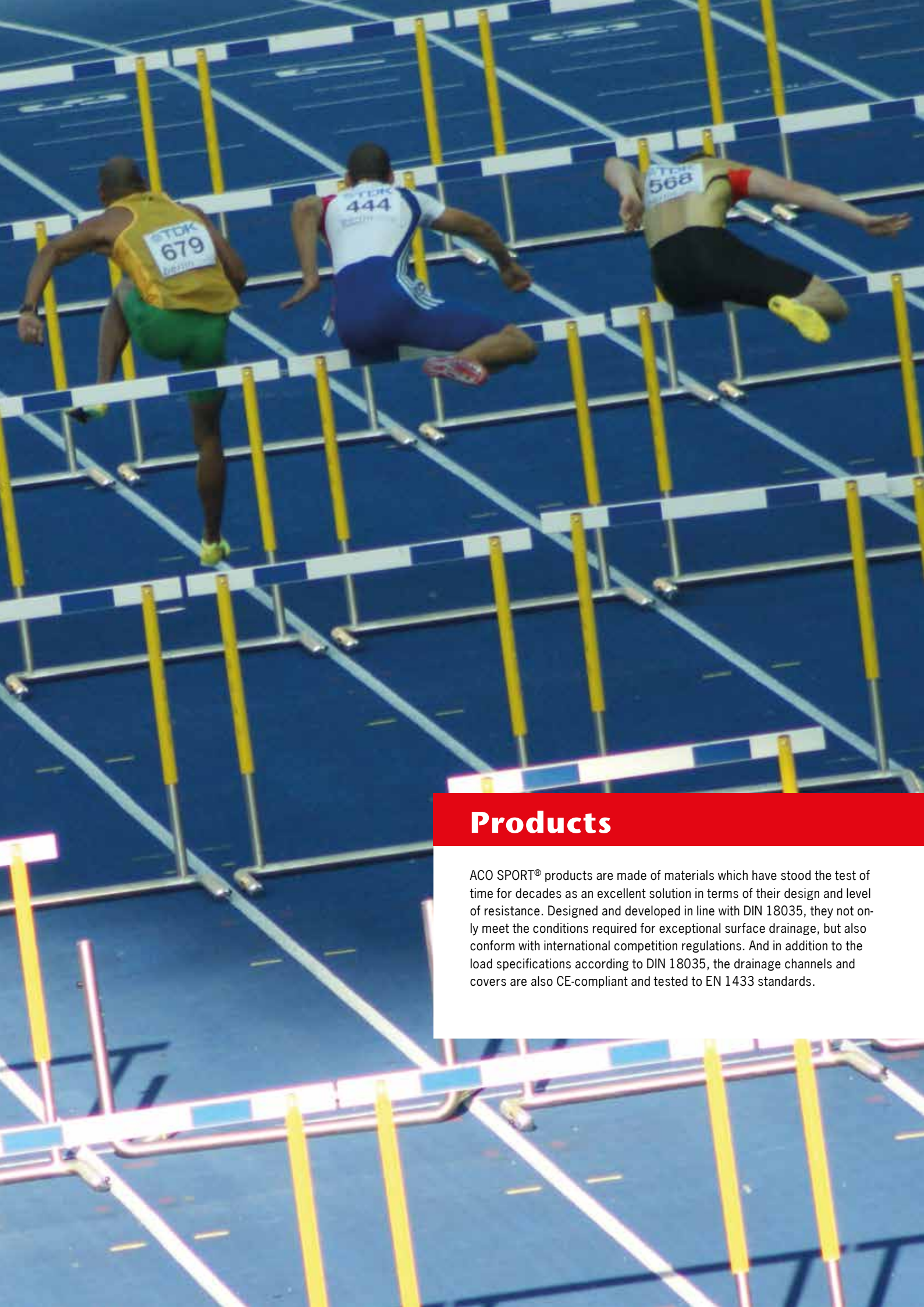

## Products

ACO SPORT® products are made of materials which have stood the test of time for decades as an excellent solution in terms of their design and level of resistance. Designed and developed in line with DIN 18035, they not only meet the conditions required for exceptional surface drainage, but also conform with international competition regulations. And in addition to the load specifications according to DIN 18035, the drainage channels and covers are also CE-compliant and tested to EN 1433 standards.

### Box channel clear width 125

As a hidden channel according to DIN 18035 Part 3  
For plastic cover

#### Box channel with wall flange

	Straight	Curved	Special radius	
Radius (m)	–	36.5	24	48
Clear width (mm)	125	125	125	125
Length (mm)	1000	1000	1000	1000
Width (mm)	175	175	175	175
Height (mm)	240	240	240	240
Weight (kg)	19.0	19.0	20.0	20.0
Art. no.:	<b>00585</b>	<b>00586</b>	<b>00595</b>	<b>00596</b>



Box channel  
The design with the wall flange has a 4 cm high cast-on turf support on the turf side.

#### Box channel without wall flange

	Straight	Curved	Special radius	
Radius (m)	–	36.5	24	48
Clear width (mm)	125	125	125	125
Length (mm)	1000	1000	1000	1000
Width (mm)	160	160	160	160
Height (mm)	200	200	200	200
Weight (kg)	17.0	17.0	18.0	18.0
Art. no.:	<b>00581</b>	<b>00582</b>	<b>00591</b>	<b>00592</b>



Box channel without wall flange

#### Other features

- Frost-resistant polymer concrete
- High strength values for class A/B EN 1433, low weight, and easy to transport and install
- Minimal roughness on the inner surfaces for low soiling potential and easy cleaning
- Smooth streaming channel, high flow rate and large throughput
- Resistant to freeze/thaw cycles
- Tongue-and-groove system for accurate, made-to-measure laying
- Moulded compartments to house potential locking mechanisms for protection against unauthorised removal of the covers
- Integrated spacers for installation support

### Inlet shaft for box channel LW125

	With wall flange	Without wall flange
Length (mm)	500	500
Width (mm)	175	160
Height (mm)	510	470
Weight (kg)	19.0	18.5
Art. no.	<b>00603</b>	<b>00601</b>



Inlet shaft  
With wall flange



Inlet shaft  
Without wall flange

#### Other features

- Frost-resistant polymer concrete
- Pre-mouldings on both sides for DN 150 gully sockets with lip seal and one side closed off with a removable socket plug. Sludge bucket included in scope of delivery
- The open side is sealed with an end cap when used at the end of the channel
- A plastic cover is provided as it is for the box channels

**Plastic cover for box channel clear width 125**

Cover for hidden channels according to DIN 18035 Part 3

	Straight	Curved
Radius	–	36.5
Length (mm)	1000	1000
Width (mm)	160	160
Height (mm)	50	50
Weight (kg)	2.8	2.8
Art. no.:	<b>00360</b>	<b>00361</b>



Plastic cover

The plastic covers can also be used in existing facilities for polymer-concrete sports channels.

**Other features**

- GF-UP (glass-fibre-reinforced plastic with unsaturated polyester resin)
- The material has outstanding levels of resistance to weathering and UV
- The covers have an environmentally friendly, water-bound coating for an even colouring and added protection against environmental influences
- The solid wall thickness of 5 mm and the resulting weight makes the covers both easy to lay and stable. The covers are laid so that the front edges overlap and they do not require fixing aids
- Machined fixing pins prevent horizontal slippage
- The edges are rounded with a radius of 20 mm in accordance with DIN 18035
- The smooth, white surface structure creates an excellent self-cleaning effect in the event of precipitation
- Maintenance equipment can pass over the top without any problems. A 15 load capacity in line with DIN 18035 is tested to EN 1433 standards
- A locking mechanism for protection against unauthorised removal can also be supplied on request

The overlapping front edges mean the covers can also be laid in special radii of up to R 22 m

**Accessories**

	Pipe sockets DN 100	Pipe sockets DN 150	End cap Galvanised steel
Length (mm)	100	200	–
Width/diameter (mm)	110	160	160
Height (mm)	–	–	200
Weight (kg)	0.2	0.4	0.4
Art. no.	<b>02614</b>	<b>02615</b>	<b>15714</b>

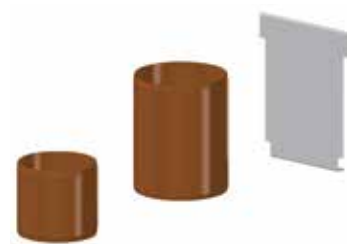

Pipe sockets and end caps



## Slot channel clear width 125

### Hollow-profile channel according to DIN 18035 Part 3

ACO SPORT® slot channel clear width 125 drainage systems are designed to comply with IAAF guidelines and DIN 18035 Part 3. With their hollow-profile channels, these system also comply with

international competition rules. They even take current FIFA/UEFA regulations for draining and marking out the pitch into consideration.

### Slot channel: can be layered over on one side, with stop ridge, groove and lawn edge

	Straight	Curved
Radius (m)	–	36.5
Clear width (mm)	125	125
Length (mm)	1000	1000
Width (mm)	160	160
Height (mm)	200	200
Weight (kg)	31.0	31.0
Art. no.:	15519	15525

Complete with groove and solid stop ridge on the track side for layering over with a 13 mm synthetic surface in situ. Wide edge on the lawn side to attach track signage.



Slot channel: can be layered over on one side

### Slot channel can be layered over completely without stop ridge

	Straight	Curved	Special radius	
Radius (m)	–	36.5	24	48
Clear width (mm)	125	125	125	125
Length (mm)	1000	1000	1000	1000
Width (mm)	160	160	160	160
Height (mm)	187	187	187	187
Weight (kg)	26.5	26.5	27.5	27.5
Art. no.:	00587	00588	00597	00598

For completely layering over with a 13 mm synthetic surface in situ, but can also be used when laying track material.



Slot channel: can be layered over

### Slot channel can be layered over on both sides, with stop ridge and groove

	Straight	Curved
Radius (m)	–	36.5
Clear width (mm)	125	125
Length (mm)	1000	1000
Width (mm)	160	160
Height (mm)	200	200
Weight (kg)	28.7	28.7
Art. no.:	15547	15550

Complete with groove and solid stop ridge on both sides for layering over with a 13 mm synthetic surface in situ.



Slot channel: can be layered over on both sides

### Other features

- Frost-resistant polymer concrete
- Standardised inlet slot to allow water to enter from above
- Smooth inner surface to ensure high flow rates and throughput
- Excellent self-cleaning capacity
- Wide trough base for secure positioning in the concrete bed
- Low weight, easy to transport and easy to install
- Inlet slot with reinforced bar to prevent compression
- Installation alignment aids thanks to the tongue-and-groove system on the front
- Suitable for people in wheelchairs
- Load capacity of C 25/0 for hollow-profile channels in line with DIN 18035 requirements, tested to EN 1433 standards



**Inlet shaft and inspection element for slot channel clear width 125 as a gully or inspection box**

	Inlet shaft	Revision element
Clear width (mm)	125	125
Length (mm)	500	500
Width (mm)	165	165
Height (mm)	483	198
Weight (kg)	16.7	11.2
Art. no.:	<b>00604</b>	<b>15574</b>



Inlet shaft for slot channel clear width 125

**Other features**

- Frost-resistant polymer concrete
- Pre-mouldings on both sides for DN 150 gully sockets with lip seal and one side closed off with a removable socket plug. Sludge bucket included in scope of delivery
- With stainless steel frame. Top edge at the height of the finished surface to facilitate installation at the correct height and make it easier to mark the recess in the cover after attaching the surface



Inspection element

**Slotted cover for inlet shaft and inspection element**

Art. no.	Properties
<b>15549</b>	Can be layered over on both sides, with stop ridge
<b>15523</b>	Can be layered over on one side, with a lawn edge
<b>15720</b>	Can be layered over, without stop ridge

**Slot channel accessories**

	Pipe sockets DN 100	Pipe sockets DN 150	End cap Galvanised steel
Length (mm)	100	200	–
Width/diameter (mm)	110	160	160
Height (mm)	–	–	200
Weight (kg)	0.2	0.4	0.4
Art. no.:	<b>02614</b>	<b>02615</b>	<b>15714</b>

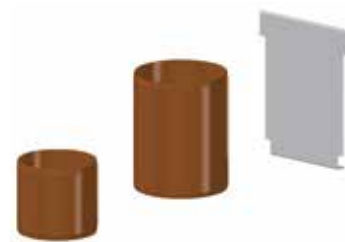

Pipe sockets and end caps

Mobile track perimeter in line with IAAF regulations, see Page 32

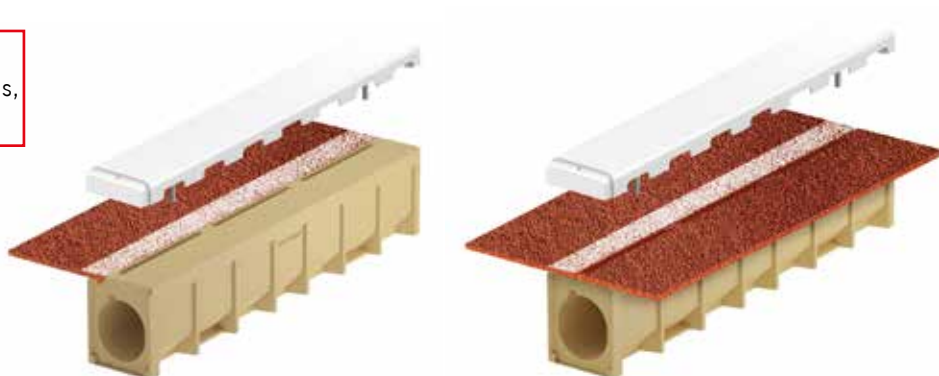

**Blind plastic cover for slot channel clear width 125**  
**Cover for hollow-profile channels according to DIN 18035 Part 3**

To be eligible to host races over 200 m, the running track must be demarcated with an inner kerb in accordance with international competition rules. At 5 cm high, this inner kerb should be made of materials which are easy to handle so that they can be removed with ease on a temporary basis during field events. The mobile ACO SPORT® blind plastic covers are inserted into the slots in the channels with ease using pins. The pre-set position of the pins beneath the cover means that the inner edge of the running

track is automatically restricted when positioning the channel cover on top of the slot channels. It also offers variable opening options for providing access from the track to the sectors. The slot openings are arranged on both sides of the cover in line with the applicable standard to allow the unimpeded access of water from the running track and sports surface (sector) to the slot channels.

	Straight	Curved
Radius (m)	–	36.5
Length (mm)	1000	1000
Width (mm)	160	160
Height (mm)	50	50
Weight (kg)	2.7	2.7
Art. no.:	<b>00363</b>	<b>00362</b>

Mobile ACO SPORT® plastic covers are suitable for use in both new and existing facilities.



Blind plastic cover

The overlapping front edges mean the covers can also be laid in special radii of up to R 22 m.

**Other features**

- GF-UP (glass-fibre-reinforced plastic with unsaturated polyester resin)
- The material has outstanding levels of resistance to weathering and UV
- The covers have an environmentally friendly, water-bound coating for an even colouring and added protection against environmental influences
- The solid wall thickness of 5 mm and the resulting weight makes the covers both easy to lay and stable. The covers are laid so that the front edges overlap and they do not require fixing aids
- Screwed-in guide pins promote rapid assembly with a precision fit
- The edges are rounded with a radius of 20 mm in accordance with DIN 18035
- The smooth, white surface structure creates an excellent self-cleaning effect in the event of precipitation
- Maintenance equipment can pass over the top without any problems. A 15 load capacity in line with DIN 18035 is tested to EN 1433 standards
- A locking mechanism for protection against unauthorised removal can also be supplied on request





## Trough channel clear width 185

### Open channels according to DIN 18035 Part 3

The ACO SPORT® running track drainage system with open troughs is suitable for cinder tracks, surrounds for large playing areas with filled-pile artificial turf, or synthetic surrounding areas.

This is the system of choice for draining type C/D single-level playing fields and

sports facilities, but is also suitable for all-weather pitches and contemporary sports facilities. So if you're looking for a seamless, low-maintenance and robust transition to the playing area, look no further than ACO SPORT® troughs.

#### Other features

- Frost-resistant polymer concrete
- Load capacity in accordance with standard class C 250
- Smooth surface, high flow rate
- Easy to clean and low maintenance
- Anti-shift protection

### Trough channel with marked edge, concrete anchor and reinforcing bars for cinder running tracks

	Straight	Curved
Radius (m)	–	36.6
Clear width (mm)	185	185
Length (mm)	1000	1000
Width (mm)	250	250
Height (mm)	70	70
Weight (kg)	28.0	28.0
<b>Art. no.:</b>	<b>15569</b>	<b>15570</b>



Polymer-concrete trough channel with 5 cm wide edge for the running track, and an optional running track groove for nuts for interlocking single-part covering.

### Trough channel with concrete anchor, reinforcing bars and groove for synthetic running tracks

	Straight	Curved
Radius (m)	–	36.6
Clear width (mm)	185	185
Width (mm)	250	250
Length (mm)	1000	1000
Height (mm)	70	70
Weight (kg)	26.0	26.0
<b>Art. no.:</b>	<b>15716</b>	<b>15717</b>

## Inlet shaft for trough channel

### Inlet shaft with sludge bucket and ladder grating

	Inlet shaft for cinder running track	Inlet shaft for running track with groove for nuts for interlocking single-part covering
Clear width (mm)	185	185
Length (mm)	600	600
Width (mm)	250	250
Height (mm)	353	353
Weight (kg)	30.0	29.0
<b>Art. no.:</b>	<b>00812</b>	<b>15718</b>

As a result of the low, standardised trough depth, the hydraulic flow rate is lower than in covered channels or slot channels. The length of the channel trains between two inlet shafts should not be longer than 20 m for trough channels.



Inlet shaft with 60 cm trough channel upper and groove

## Trough channel accessories

	Pipe sockets DN 100	Expansion profile set*	End cap Galvanised steel
Length (mm)	100	–	–
Width/diameter (mm)	110	250	250
Height (mm)	–	–	150
Weight (kg)	0.2	0.05	0.3
<b>Art. no.:</b>	<b>02614</b>	<b>15708</b>	<b>15715</b>

\*Recommended for installation on both sides of the inlet shaft to accommodate the changing length of trough channels due to temperature fluctuations.



Trough channel accessories

### Elastic kerbstones

Sports surfaces and playing fields in all types of arenas and other associated facilities must have a secure perimeter in place which provides protection against injury. With their high-quality, durable design, ACO SPORT® elastic kerbstones are a reliable choice when it comes to surrounds. They can be used in arenas in a variety of different ways, for example as the outer perimeter for running tracks or run-ups, for demarcating sectors from the playing area, and separating off pits. In secondary facilities, ACO SPORT® elastic kerbstones are used to separate shot put and long jump training areas, all-weather pitches or other sports facilities, and even in nurseries. If the kerbstone is intended as a marker, for exam-

ple as a perimeter for a running track or segment, then ACO SPORT® elastic kerbstones with their 5 cm white cushioning profile are the products of choice. ACO SPORT® elastic kerbstones are made of polymer concrete with a white cushioned rubber upper (EPDM). This is also available in black on request. The rubber profile is firmly cast into the polymer concrete base. Integrated air compartments within the design provide a high degree of elasticity and maximum safety. The adjustable feet and moulded compartments on one side provide a secure fit within the concrete bed.



Elastic kerbstones as a soft edge with black and white cushioning profile

#### Elastic kerbstones, black

Height (mm)	200			250		300		400	
Length (mm)				1000		500		1000	500
Width (mm)	50	60	100	50	100	60	60	60	60
Weight (kg)	12.5	16.5	24.0	14.6	26.8	18.3	9.2	23.7	10.5
Art. no.	<b>01690</b>	<b>01034</b>	<b>01773</b>	<b>01035</b>	<b>01774</b>	<b>01036</b>	<b>01573</b>	<b>01037</b>	<b>01574</b>

#### Elastic kerbstones, white

Height (mm)	200			250		300		400	
Length (mm)				1000		500		1000	500
Width (mm)	50	60	-	50	-	60	60	60	60
Weight (kg)	12.5	16.5	-	14.6	-	18.3	9.2	23.7	10.5
Art. no.	<b>01689</b>	<b>00961</b>	-	<b>00962</b>	-	<b>00963</b>	<b>01571</b>	<b>00964</b>	<b>01572</b>

#### Elastic kerbstones, corner piece, black

Height (mm)	250	300	400
Length (mm)	250/250		
Width (mm)	50	60	60
Weight (kg)	8.9	12.5	13.2
Art. no.	<b>01041</b>	<b>01380</b>	<b>01042</b>

#### Elastic kerbstones, corner piece, white

Height (mm)	250	300	400
Length (mm)	250/250		
Width (mm)	50	60	60
Weight (kg)	8.9	12.5	13.2
Art. no.	<b>00968</b>	<b>01381</b>	<b>00969</b>

#### Other features

- Frost-resistant polymer concrete
- Rubber profile made of elastic, long-life, weather-resistant EPDM
- Moulded air compartments for maximum possible safety
- Profile firmly cast into the support
- Profile height rounded to approx. 30 mm on all sides
- 90-degree corner pieces with inner leg dimensions of 25 x 25 cm



## Sand capture channel

ACO SPORT® sand capture channels are recommended for long jump pits located within a high-quality synthetic surface. If any sand escapes from the pit, which is inevitable during long jump events, then this is collected by the sand capture channels to keep it off the surrounding surface. This not only protects the synthetic surface from abrasion and wear, but also maintains its permeability and prevents puddles. As a result, service and maintenance costs are kept to an absolute minimum.

Depending on the overall width required,

sand capture channels can be positioned in one or two rows around the long jump pit but not in the run-up area. These are installed alongside 6 cm wide ACO SPORT® elastic kerbstones, which are used to demarcate the pit. This increases the outer dimensions of the pit to 12 cm. So to compensate for this resulting misalignment and create corners which fit perfectly, the product range includes components at 56 cm long to act as spacer pieces.



Sand capture channel as an outer channel

	Inner channel		Outer channel		End cap
Length (mm)	1000	560	1000	560	
Width (mm)	500	500	500	500	
Height (mm)	140	140	140	140	140
Weight (kg)	42.5	24.5	40.2	23.1	0.7
<b>Art. no.</b>	<b>01474</b>	<b>01476</b>	<b>01475</b>	<b>01477</b>	<b>15571</b>



For installation plans for long jump equipment in accordance with IAAF guidelines, specifically relating to sand capture channels, see page 53

### Other features

- Base made of frost-resistant polymer concrete
- Cover made of non-slip, galvanised, plug-in metal grating with a secure rubber mat over the top to protect against injury
- Metal edge for a clean finish to the synthetic surface
- Pre-formed break points for DN 100 connection ports in the base to drain pools of water
- Inner channel for laying in two rows to increase the installation width as required
- 56 cm spacer pieces
- Smooth inner surface for easy cleaning



## Surrounding slab

ACO SPORT® surrounding slabs are used to distinguish between areas of vegetation and artificial surfaces, for example on the outer edge of a running track. The 25 cm slab width prevents grass and weeds from coming into contact with expensive artificial surfaces, thereby protecting the running track or playing surfaces against damage caused by roots. Made of tested concrete, ACO SPORT® surrounding slabs are 13 mm lower on

one side so that they can be covered over with the synthetic surface. The stop ridge ensures an accurate finish, while the integrated ridge guarantees that this surface covering stays in position in the long term. And at a minimum of 15 cm wide, the visible concrete surface is skid resistant thanks to its textured finish.



Surrounding slab

	Surrounding slab with stop ridge and groove	Expansion profile set* 2 pieces
Length (mm)	500	10
Width (mm)	250	250
Height (mm)	70	150
Weight (kg)	18.0	0.1
<b>Art. no.:</b>	<b>15713</b>	<b>15709</b>

\*We recommend installing an expansion profile with a channel length of approx. 10 m to accommodate the changing length due to temperature fluctuations.

### Other features

- Concrete tested in line with German Civil Code (BGB) guidelines by German quality assurance company, Güteschutz Beton- und Fertigteilwerke Nord
- Just 50 cm long for straightforward handling and laying in the radius
- Compact, heavyweight component meaning no hollows are required for positioning in the concrete bed
- 7 cm height allows concrete back-rests to be attached at the sides for anchorage
- Moulded groove on the base for anti-shift protection



## Surrounding kerb

ACO SPORT® surrounding kerbs are used to distinguish between areas of vegetation or paved areas and artificial surfaces, for example on the outer edge of a running track or as a perimeter around synthetic sports surfaces.

Made of tested concrete, ACO SPORT® surrounding kerbs are 13 mm lower on one side so that they can be covered over with

the synthetic surface. The stop ridge ensures an accurate finish, while the integrated ridge guarantees that the synthetic surface covering stays in position in the long term. The visible concrete surface is skid resistant thanks to its textured finish and rounded on the outer edge.



Surrounding kerb

	Surrounding kerb with stop ridge and groove
Length (mm)	1000
Width (mm)	80
Height (mm)	200
Weight (kg)	34.5
Art. no.:	15739

### Other features

- Concrete tested in line with German Civil Code (BGB) guidelines by German quality assurance company, Güteschutz Beton- und Fertigteilwerke Nord
- Slimline, visible concrete surface of just 4 cm
- Minimal joint gaps when laying in radii of >40 m

## Cable distribution shaft

Many of today's sports facilities include audio and lighting systems. Even electronic measuring devices have to be connected to the power supply without any complications.

ACO SPORT® cable distribution shafts house electronic and communication cables and, as a key component of the permanent cabling system, provide the necessary power supply – particularly inside sports facilities. As the cabling system is permanently installed, the risk of accidents due to stray cables is reduced. Not only this, but it also ensures that measuring equipment, mobile lighting, scoreboards and electronic transmitters can be connected in no time. Depending on the installation site, two different galvanised-steel covers are available to choose from:

- For paved areas which sit flush with the corrugated plate.
- For inside stadiums, designed as a tank for layering over with 13 mm thick synthetic surfaces or artificial turf.

The ACO SPORT® cable distribution shaft is open in the base area. Any condensation must be drained off by means of a sufficiently deep seepage channel in the shaft base. Mains sockets can be found in the centre of the perforated plate within the shaft, which provides protection against both perspiration and condensation.



Cable distribution shaft

	With a galvanised cover which can be layered over	With a galvanised corrugated plate cover for paved areas
Length (mm)	600	600
Width (mm)	600	600
Height (mm)	600	600
Weight (kg)	89.0	89.0
Art. no.	01333	15540

### Other features

- Load capacity class B 125, DIN EN 12
- Pre-mouldings on all sides for connecting DN 100 and DN 125 cable conduits
- Base made of frost-resistant polymer concrete
- Solid, galvanised-steel frame with glands
- Handle opening and cable duct
- Mounted perforated plate for installing mains sockets
- Cable holder under the cover

### Trough channel for rectangular playing areas With filled-pile artificial turf or natural turf

The symmetrical finish of the trough channel provides a high-quality border which is capable of supporting traffic. It is suitable for use in sports areas with special artificial turf filled with a granulate mixture of sand and rubber crumb or

cork. If surface water collects quickly, then the smooth, DIN-standard trough drains it off whilst also quickly removing granulate. The compact component is capable of supporting traffic up to load class B 125 in accordance with

EN 1433. With moulded anchors to act as clamps and moulded reinforcing bars, it has a firm grip on the base of the strip. It is even possible to pave directly over the vertical side walls.

### Straight trough channel with concrete anchor for rectangular playing areas, particularly large playing areas with granulate-filled artificial turf

	Trough channel Straight	Inlet shaft
Clear width (mm)	185	185
Length (mm)	1000	600
Width (mm)	220	220
Height (mm)	60	348
Weight (kg)	18.0	22.0
Art. no.:	<b>15566</b>	<b>15568</b>



Straight trough channel for rectangular playing areas



Inlet shaft for rectangular playing areas

As a result of the low, standardised trough depth, the hydraulic flow rate is lower than in covered channels or slot channels. The length of the channel trains between two inlet shafts should not be longer than 25 m for trough channels.

#### Other features

- Frost-resistant polymer concrete
- Smooth surface, high flow rate
- Easy to clean and low maintenance
- Anti-shift protection
- Two concrete anchors, firmly cast in place

### Trough channel accessories

	Pipe sockets DN 100	Expansion profile set*	End cap Galvanised steel
Length (mm)	100	-	-
Width/diameter	110	250	250
Height (mm)	-	-	150
Weight (kg)	0.2	0.05	0.3
Art. no.	<b>02614</b>	<b>15708</b>	<b>15715</b>

\*Recommended for installation on both sides of the inlet shaft to accommodate the changing length of trough channels due to temperature fluctuations.



Trough channel accessories



## Trough channel with angled rail for artificial turf clamping For traditional artificial turf

The trough channel for securing the artificial turf provides a high-quality border which is capable of supporting traffic. It is suitable for use in sports areas with a traditional artificial turf which is fixed to the edges of the pitch.

If surface water starts to collect, then this the smooth, DIN-standard trough drains it off quickly. The compact component is capable of supporting traffic up to load class C 250 in accordance with EN 1433. With moulded clamps and reinforcing bars, it has a firm grip on the base of the strip. It is even possible to pave directly over the vertical side walls. The turf is easy to secure in place using an aluminium clamping rail.

## Trough channel with clamping device for conventional artificial turf, for rectangular playing areas, particularly hockey pitches

	Trough channel Straight	Inlet shaft complete with bucket and plastic ladder grating
Clear width (mm)	185	185
Length (mm)	1000	600
Width (mm)	260	260
Height (mm)	75	363
Weight (kg)	30.6	33.5
Art. no.:	<b>15737</b>	<b>15738</b>

As a result of the low, standardised trough depth, the hydraulic flow rate is incomparable to that found in covered channels or slot channels. As a result, the length of the channel trains between two inlet shafts should not be longer than 25 m for trough channels.

### Other features

- Frost-resistant polymer concrete
- Corrosion-resistant fixing equipment made of aluminium and steel
- Smooth surface, high flow rate
- Easy to clean and low maintenance
- Anti-shift protection
- Two concrete anchors, firmly cast in place



Trough channel with clamping rail



Inlet shaft with clamping rail and plastic ladder grating

## Clamping block with clamping rail

The ACO SPORT® clamping block is used to secure the artificial turf with an unfilled pile layer. It also acts as a border between the artificial turf surface and the surrounding area. The clamping block itself is made of polymer concrete with moulded drill holes for dowels and stainless-steel fixing screws. The artificial turf is secured with an aluminium clamping rail, which is firmly attached to the polymer-concrete base with screws.

### Other features

- Base material: frost-resistant polymer concrete
- Corrosion-resistant fixing equipment made of aluminium and steel
- High strength values, low weight, easy to transport and easy to install
- Adjustable feet and moulded compartments provide a secure fit within the concrete bed

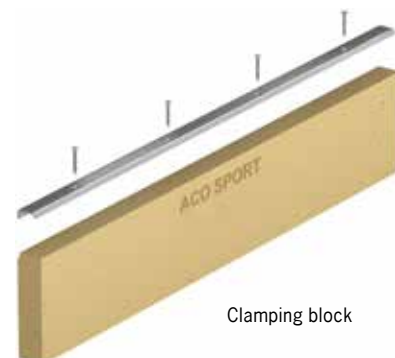

Clamping block

	Kerbstone with aluminium angled rail and V2A fixing
Length	1000
Width (mm)	50
Height (mm)	180
Weight (kg)	12
Art. no.:	<b>01182</b>

## Point drainage for area drainage

It can be necessary to drain surface water at certain individual locations in some sports areas or sections depending on the respective structural requirements or ground conditions.

### Point drain for sports surfaces to be integrated into the border around cinder and synthetic surfaces

ACO SPORT® point drainage systems are installed between the border elements at the edge of the synthetic or cinder surfaces to be drained. The gully box and cover are made of polymer concrete. The system comes complete with an integrated bucket for collecting sediment.

The covers for the point drainage system fit kerbstones of 5 cm or 6 cm wide. Water is generally fed away from point drainage systems by means of a closed DN 100 pipeline, although a seepage option is also available in individual cases.

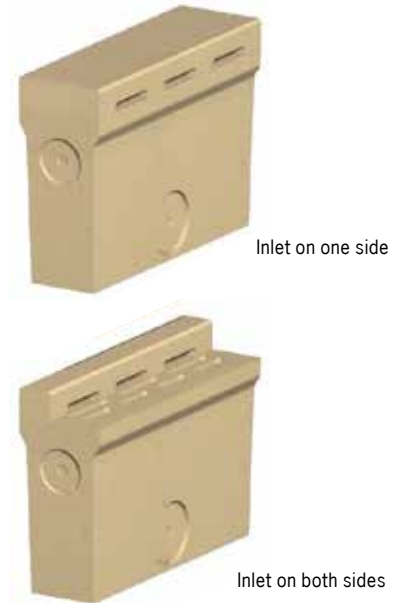

	Inlet on one side		Inlet on two sides	
	5.0	6.0	5.0	6.0
For kerbstone				
Width (cm)	5.0	6.0	5.0	6.0
Length (mm)	500	500	500	500
Width (mm)	155	155	155	155
Height (mm)	357	357	357	357
Weight (kg)	22.4	22.4	18.5	18.5
Art. no.	<b>01865</b>	<b>02035</b>	<b>01866</b>	<b>02036</b>

#### Other features

- Intake area when covered
  - One-sided inlet: 51.0 cm<sup>2</sup>
  - Two-sided inlet: 82.9 cm<sup>2</sup>





**Stainless-steel point drainage for concrete or poured asphalt surfaces in skate parks or roller-sports facilities**

For draining surfaces at roller-sports facilities, for example, stainless-steel point drainage systems are the products of choice, as this material makes them corrosion resistant, weatherproof and robust. The functional covers have been

adapted to sporting environments with their large intake area and safe, screw-locked design. They also include an integrated dirt trap with a large retention volume, while the DN 100 outlet is designed for connecting all conventional KG pipes.

	Square with rod grating	Round with perforated grating
Length (mm)	300	–
Width/diameter (mm)	300	Ø 305
Height (mm)	350	350
Socket	Ø 110	Ø 110
Weight (kg)	7.5	8.3
Art. no.:	<b>15424</b>	<b>15427</b>



**Other features**

- Stainless steel material 1.4301 (V2A)
- Square design with screwed-in longitudinal rod grating, minimal rod intervals of approx. 6 mm
- Round design with screwed-in perforated grating, hole diameter of 8 mm
- Stainless-steel sludge trap with a large volume of approx. 6.9 l
- DN 100 outlet – diameter 110 mm, suitable for conventional drainage pipes
- Can be upgraded with a waterless foul air trap as required
- Load capacity class A 15 according to DIN EN 1433



## Customised, stainless-steel channel systems for covered areas in stadiums Walkways, entrances and access points

These individual, project-based solutions involve adapting the channel dimensions to suit the level of rainfall and the size of the area to be drained.

Available in individual lengths of up to 6 metres with welded flange connections, these channels are produced with or without integrated gradients. The covers have a non-slip finish and are designed to withstand various load classes.

### Other features

- Stainless steel material 1.4404 (V4A), Covers made of stainless steel or plastic
- Safe and rapid water drainage
- Low height from 45 mm depending on the type of cover
- Welded front edges, sockets, corners or recesses
- Straight, polygonal or radial designs available
- Duct elements according to DIN 18195
- Cover types can be walked on and are also capable of supporting traffic up to class B 125 according to EN 1433



Waterproof flange connection for covered areas



Plug-in connection and perforation options for non-covered areas

**Robust, hot-dip galvanised slot channels for steps, entrances and car parks**

For draining surface water in tiered facilities, entrances and car parks, robust, hot-dip galvanised steel slot channels are the recommended choice. Particularly suitable for steps and paved areas, the vertical edges can be covered quickly and neatly. The surface water is

collected via a narrow slot and carried down the water level slope to the gully and inspection box. The hot-dip galvanised steel slot channels are capable of supporting traffic.

**Other features**

- A discreet drainage solution
- Suitable for slab and paving thicknesses of up to 10 cm
- Continuous inlet slot around the inspection boxes
- Capable of supporting traffic up to class C 250 according to EN 1433

**ino 660 slot channel – hot-dip galvanised steel**  
Slot channel clear width 90, can support traffic up to class C 250, EN 1433

	Product	Length (mm)	Width (mm)	Height (mm)	Slot height (mm)	kg/item	Item No.
	0.5 m channel	500	90	200	110	4.3	15802
	1.0 m channel	1000	90	200	110	8.6	15807
	2.0 m channel	2000	90	200	110	17.1	15800

**Inspection box with connection on both sides and removable, fillable cover**

	Product	Length (mm)	Width (mm)	Height (mm)	Slot height (mm)	kg/item	Item No.
	Inspection box	250	274	210	110	8.2	15803
	Removal hooks	145	—	—	—	0.1	15806

**Accessories**

	Product	Length (mm)	Width (mm)	Height (mm)	kg/item	Item No.
	Push-in connector	80	91	—	0.3	15804
	End cap	20	90	200	0.3	15808
	Foul air trap, waterless, stainless steel	—	—	85	0.7	100236

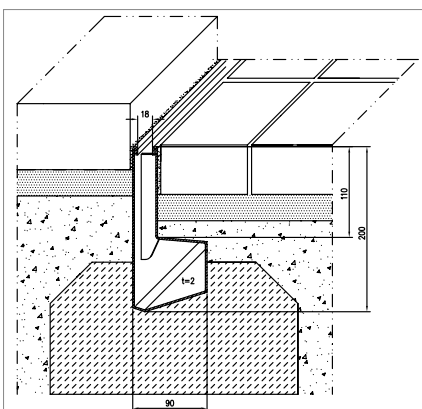

**System diagram**

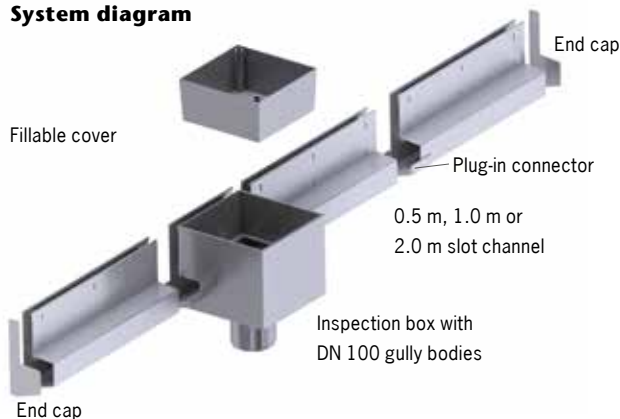

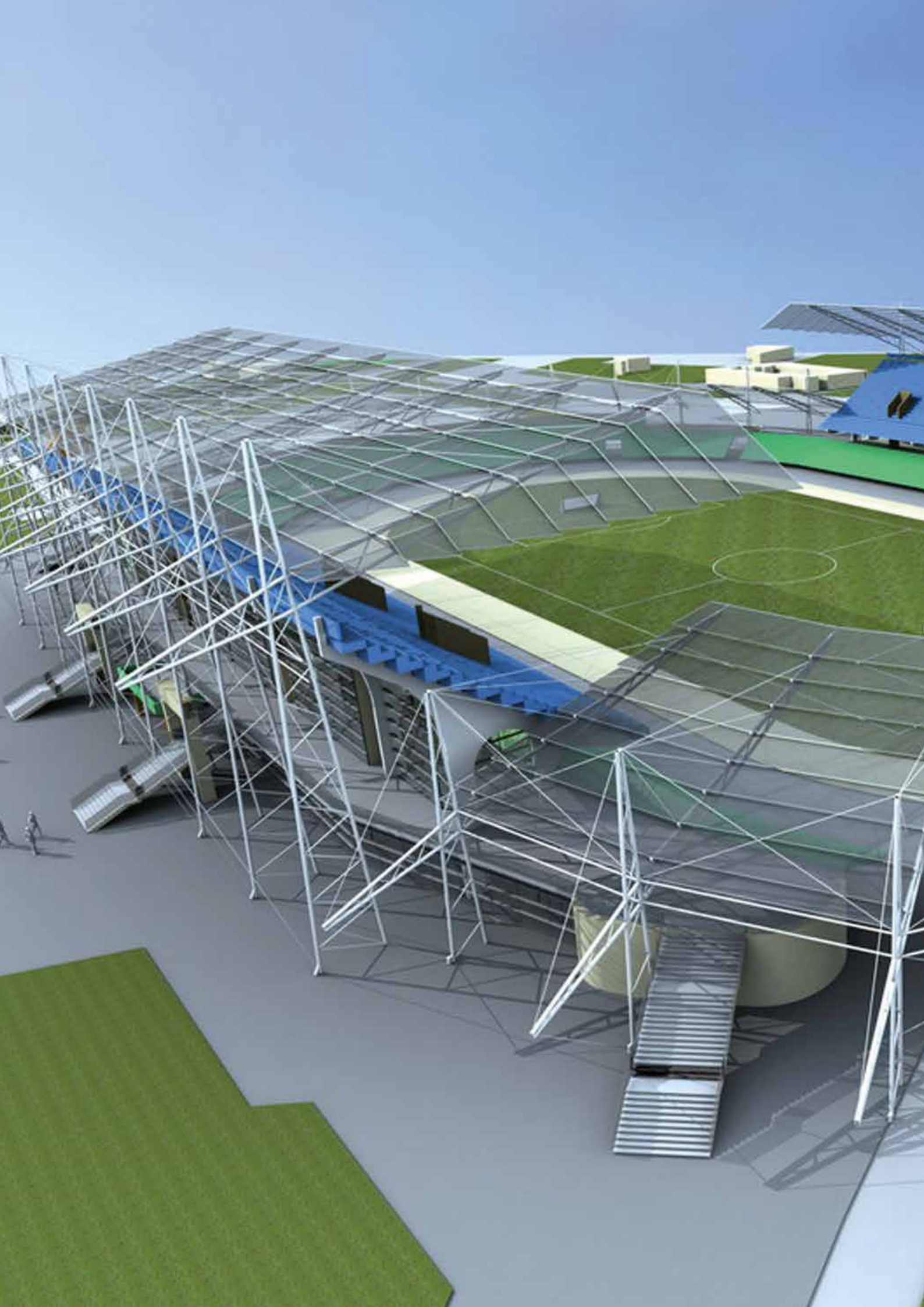

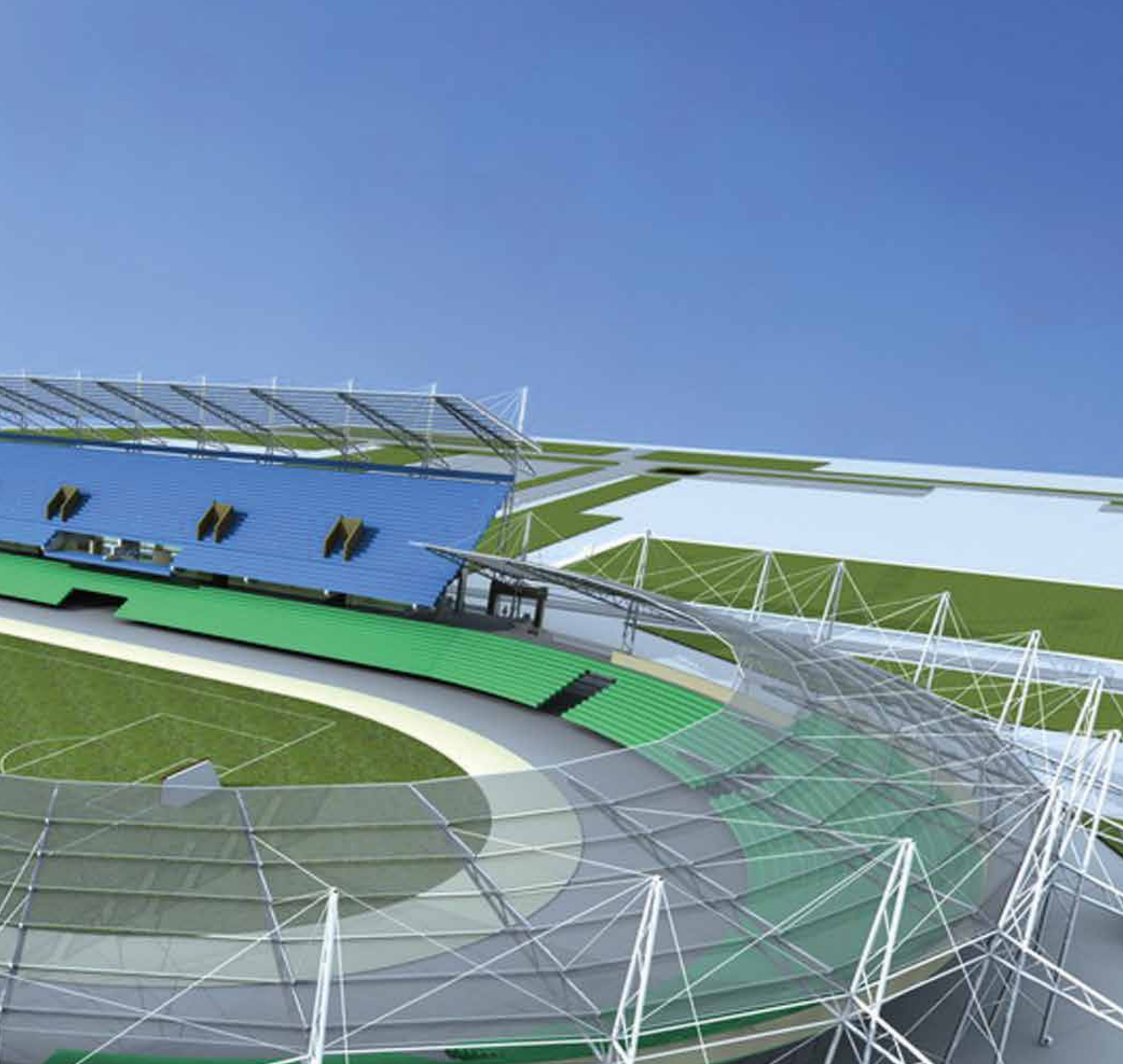

## Service

### Our planning and implementation services

From the planning stage right through to implementation, and whether it's a completely new construction or an upgrade to an existing site, the work involved in building a sports facility is extremely varied. And when it comes to getting it kitted

out and set up, the spectrum focuses on needs, requirements and usage, not to mention the specific, sports-related features of the stadium.

The installation plans we have provided are just a few case studies. We also offer

additional support for each individual item with suggestions for tender specifications and hydraulic power calculations, as well as installation plans and recommendations.

[www.aco-sport.de/service](http://www.aco-sport.de/service)

## Materials

### ACO polymer concrete – a better idea

The special composition of the materials and latest production technologies are what give ACO polymer concrete its outstanding profile: at a similar density, ACO polymer concrete products are much stronger and lighter than comparable concrete products. ACO polymer concrete is waterproof; any water on it dries quickly; and there is no chance of any frost damage. The smooth surface of ACO polymer concrete allows water and dirt particles to quickly run off whilst also making it easy to clean. What's more, polymer concrete needs no additional

coatings to make it resistant to aggressive media, and can even be used in the long term for many different purposes under extreme conditions.

Products made of ACO polymer concrete are also toxicologically safe (according to the recommendations for synthetic materials made by the German Federal Health Office for the food and beverages industry). ACO polymer concrete is straightforward to work with – including sawing and drilling – using conventional tools for stone and concrete materials.



### GF-UP

The plastic covers which go with the ACO SPORT® channels are made of GF-UP (glass-fibre-reinforced plastic with unsaturated polyester resin). This material is made up of approximately 2/3 calcium carbonate filler (chalk) with glass fibres and 1/3 unsaturated polyester resin.

To ensure uniform colouring, the cover surfaces are painted with an environmentally-friendly, water-bound coating, which also offers additional protection against environmental influences.



The polyester resin binding agent is a pure combination of carbon, hydrogen and oxygen. The material GF-UP has outstanding levels of resistance to weathering and UV.

### EPDM

The ACO SPORT® elastic kerbstone profiles are made of ethylene propylene diene terpolymer (EPDM). This rubber material has outstanding levels of resistance to temperature, weathering, UV and the ozone, and has a Shore hardness level of approx. 70° A. The profiling (compartment arrangement) of the ACO SPORT® elastic profiles lends these safety components a high level of elasticity. Care has also been taken to ensure that the edge area is sufficiently soft to keep the

risk of injury to a minimum. ACO SPORT® elastic profiles are firmly secured in the polymer-concrete base and combine to form a single unit. Even environmental influences such as frost are not able to loosen them.



## Arenas – Requirements and equipment



**Type A arena**

International and national athletics stadiums for competitions in line with IAAF guidelines



**Type B arena**

Regional stadiums for championships and events in accordance with international competition rules and the German Athletics Association (DLV)



**Type C arena**

Sports facilities with circular running track for school sport and grass-roots activities

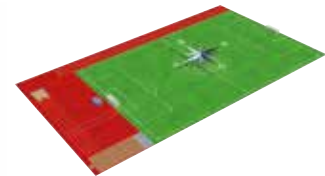

**Type D arena**

Sports facilities without circular running track for school sport and grass-roots activities

Arena	Number of lanes	Number of short lanes	Individual equipment south segment	Individual equipment north segment	Individual equipment in both segments	Individual equipment outside the running track
Type A large sports field 68 x 105 m	8–9	8–9	High jump	Water jump Shot put Pole vault area with run-up from both sides	Discus Hammer Javelin	Long jump and triple jump with run-up from both sides (east straight)
Type B large sports field 68 x 105 m	6	6–8	High jump	Water jump, pole vault, long jump and triple jump with 2–3 run-up lanes from a single side	Shot put Discus Hammer Javelin	Long jump and triple jump with run-up from both sides (east straight)
Type C large sports field 68 x 105 m	4	4-6	High jump Javelin Small sports area	Shot put Pole vault Discus Hammer, long jump and triple jump with 2–3 run-up lanes from a single side		
Type D Large, rectangular sports field with a small sports area on one		6	Shot put High jump Long jump Triple jump Shot put / javelin			

**Installation plan for type A arena**  
**Channel installation plan for an example area**  
**Type A with the following requirements:**

- Playing area and sectors at the same level as the running track
- Surface types: synthetic running track and sectors
- Playing area with natural turf

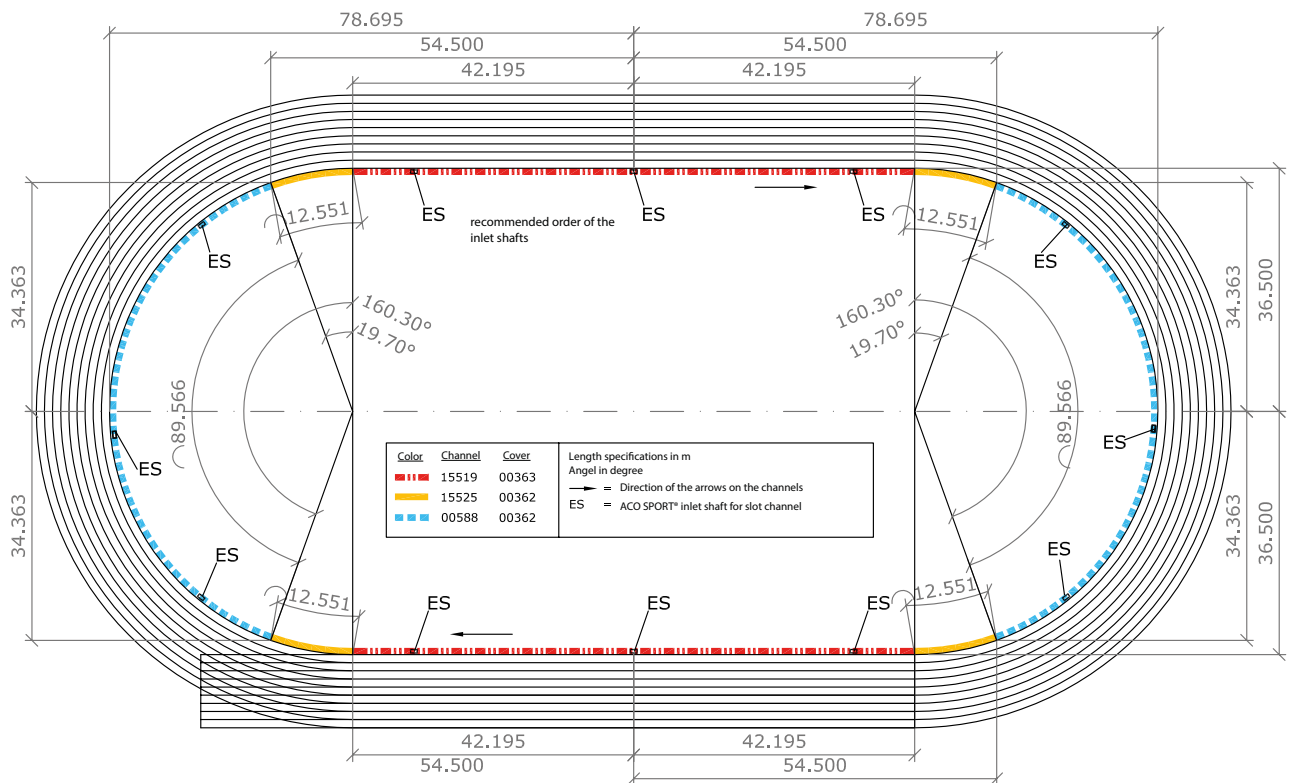

Number	Art. no.	Product
170 m	<b>15519</b>	Straight slot channel: can be layered over on one side
50 m	<b>15525</b>	Curved slot channel R 36.5 m: can be layered over on one side
180 m	<b>00588</b>	Curved slot channel R 36.5 m: can be layered over
12 pcs	<b>00604</b>	Slot channel inlet shafts
6 pcs	<b>15523</b>	Slotted cover: can be layered over on one side
6 pcs	<b>15720</b>	Slotted cover: can be layered over
12 pcs	<b>02615</b>	DN 150 connection port
170 m	<b>00363</b>	Straight, mobile track border with plastic cover
230 m	<b>00362</b>	Curved, mobile track border with plastic cover



**Installation plan for type B arena**  
**Channel installation plan for an example area**  
**Type B with the following requirements:**

- Playing area 5 cm above running track level, both sectors at the same level as the running track
- Surface types: synthetic running track and sectors
- Playing area with natural turf or optionally with filled-pile artificial turf

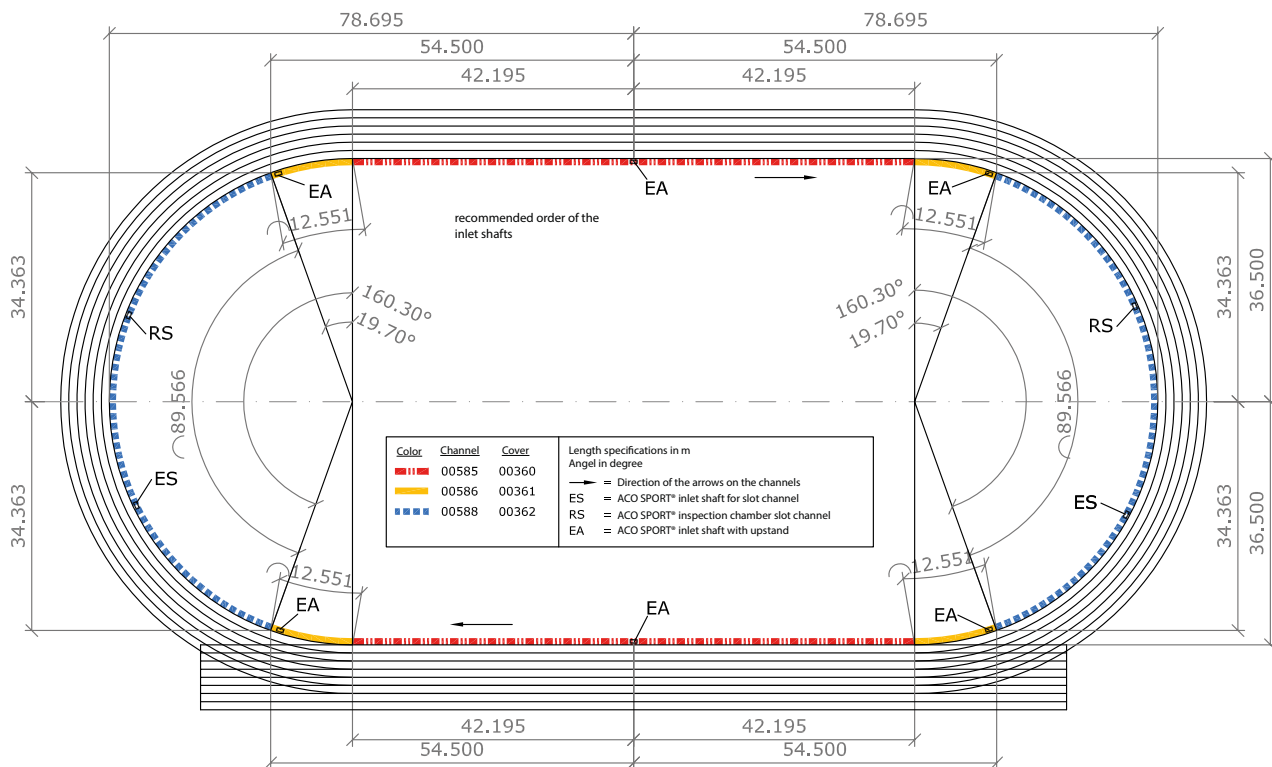

Number	Art. no.	Product
170 m	<b>00585</b>	Straight channel with 4 cm wall flange
170 m	<b>00360</b>	Straight track border with plastic cover
50 m	<b>00586</b>	Curved channel R 36.5 m with 4 cm wall flange
50 m	<b>00361</b>	Curved track border with plastic cover
180 m	<b>00588</b>	Curved slot channel R 36.5 m: can be layered over
6 pcs	<b>00603</b>	Box channel inlet shafts
2 pcs	<b>00604</b>	Slot channel inlet shafts
2 pcs	<b>15574</b>	Inspection elements
4 pcs	<b>15720</b>	Slotted cover: can be layered over
8 pcs	<b>02615</b>	DN 150 connection port
180 m	<b>00362</b>	Curved, mobile track border with plastic cover

**Installation plan for type C arena**  
**Channel installation plan for an example area**  
**Type C with the following requirements:**

- Playing field and 1 sector,  
**5 cm above running track level**
- Surface types: synthetic running track and  
 1 sector
- Playing field and 1 sector with turf  
 or optionally with filled-pile artificial turf

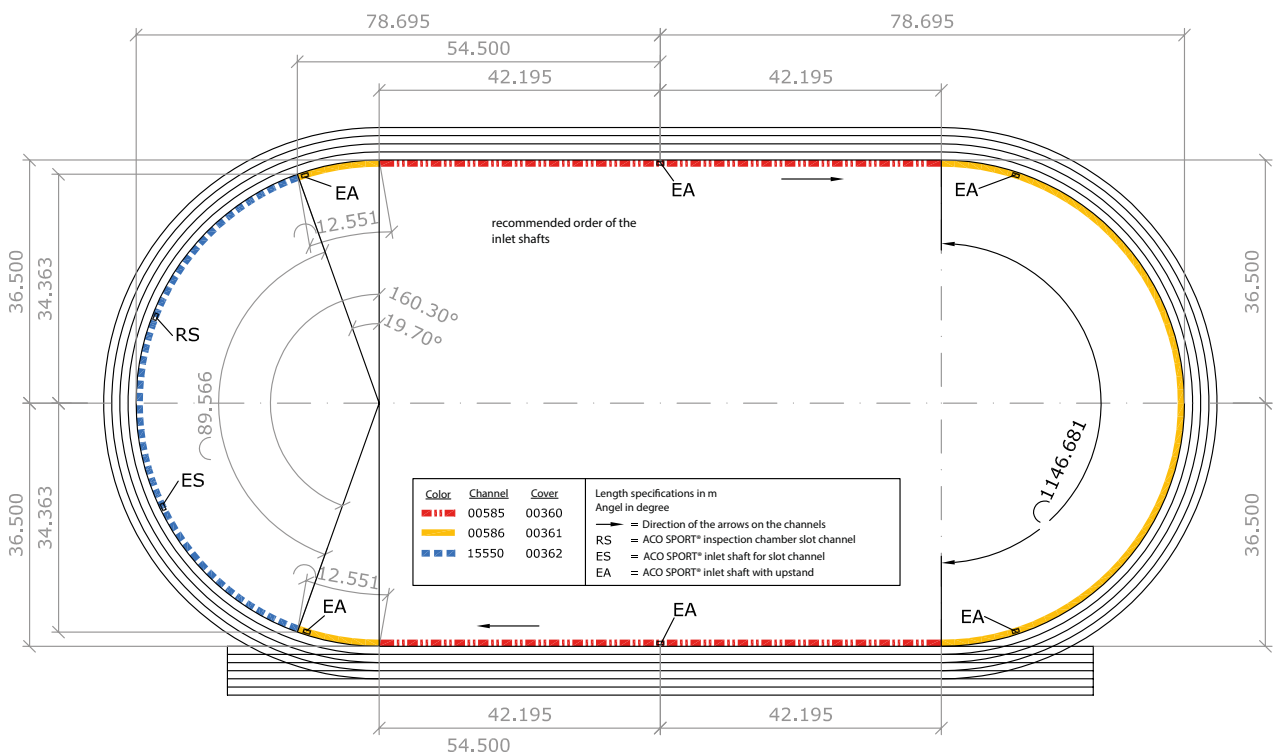

Number	Art. no.	Product
170 m	<b>00585</b>	Straight channel with 4 cm wall flange
170 m	<b>00360</b>	Straight track border with plastic cover
140 m	<b>00586</b>	Curved channel R 36.5 m with 4 cm wall flange
140 m	<b>00361</b>	Curved track border with plastic cover
90 m	<b>15550</b>	Curved channel R 36.5 m: can be layered over on both sides
90 m	<b>00362</b>	Curved, mobile track border with plastic cover
6 pcs	<b>00603</b>	Box channel inlet shafts
1 pcs	<b>00604</b>	Slot channel inlet shafts
1 pcs	<b>15574</b>	Inspection element
2 pcs	<b>15549</b>	Slotted cover: can be layered over
7 pcs	<b>02615</b>	DN 150 connection port

**Installation plan for type C arena**  
**Channel installation plan for an example area**  
**Type C with the following requirements:**

- Playing area and sectors at the **same level as the running track**
- Surface types: synthetic running track and 1 sector
- Natural turf playing area and 1 sector

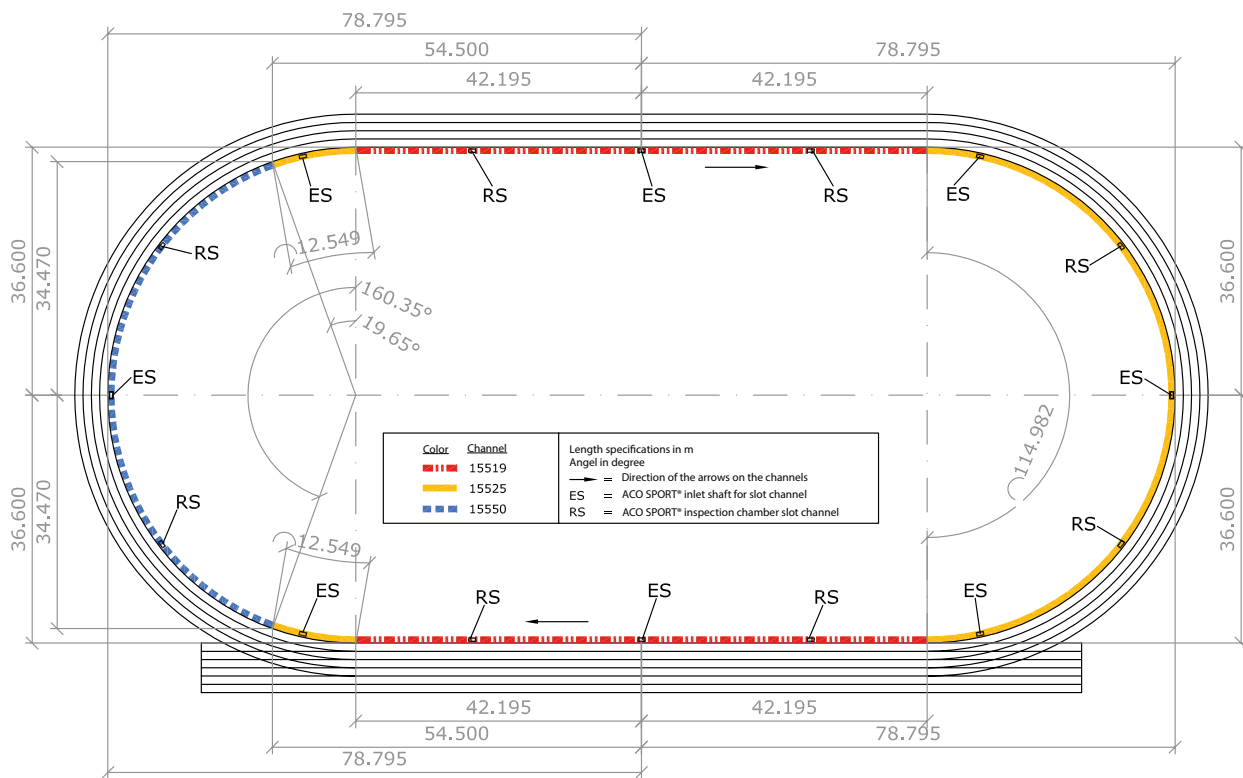

Number	Art. no.	Product
170 m	<b>15519</b>	Straight slot channel
140 m	<b>15525</b>	Curved slot channel R 36.5 m
90 m	<b>15550</b>	Curved slot channel R 36.5 m: can be layered over on both sides
8 pcs	<b>00604</b>	Slot channel inlet shafts
8 pcs	<b>15574</b>	Inspection elements
13 pcs	<b>15523</b>	Slotted cover: can be layered over on one side
3 pcs	<b>15549</b>	Slotted cover: can be layered over on two sides
8 pcs	<b>02615</b>	†DN 150 connection port

**Installation plan for type C arena**  
**Channel installation plan for an example area**  
**Type C with the following requirements:**

- Playing area and sectors at the same level as the running track
- Surface types: **Cinder running track**
- Playing area and sectors in turf, filled-pile artificial turf or cinder

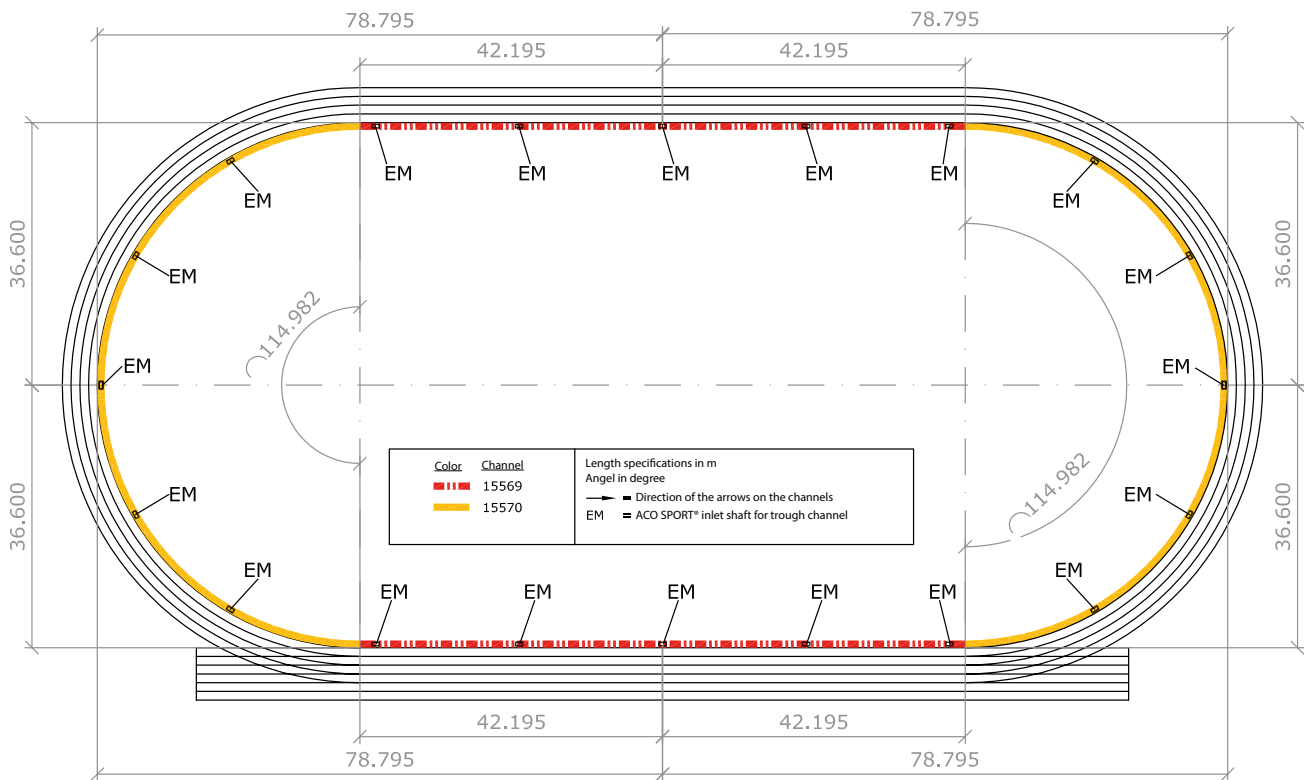

Number	Art. no.	Product
166 m	<b>15569</b>	Straight trough channel
226 m	<b>15570</b>	Curved trough channel R 36.6 m
20 pcs	<b>00812</b>	Inlet shafts
20 pcs	<b>02614</b>	DN 100 connection port
20 pcs	<b>15708</b>	Expansion joint set

### Installation plan for ACO SPORT elastic kerbstones / sand capture channels

#### 1-row – 9 x 3 m pit

■ The width of the pit with a run-up lane measures 2.75 – 3.00 m in accordance with IAAF guidelines and international competition rules. This measurement refers to the landing area and does not include the borders. The length is at least 10 m measured from the take-off board

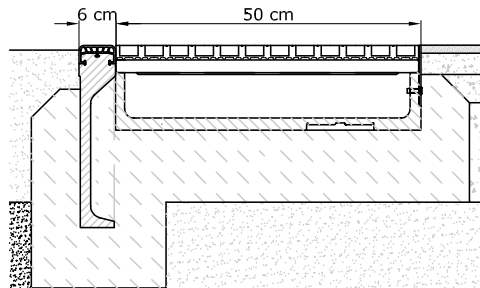
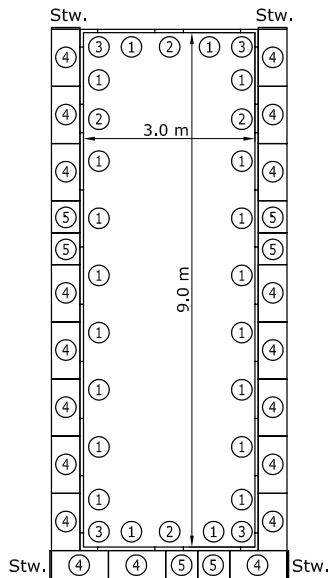

Item	Description	Art. no.	Pieces
1	100 x 40 x 6 cm kerbstone, white rubber	00964	20
2	50 x 40 x 6 cm kerbstone, white rubber	01572	4
3	25/25 x 40 x 6 cm angle, white rubber	00969	4
4	Outer sand capture channel 100 x 50 cm	01475	19
5	Outer sand capture channel 56 x 50 cm	01477	6
End cap	End cap for sand capture channel	15571	4

### Installation plan for ACO SPORT elastic kerbstones / sand capture channels

#### 2-rows – 9 x 6 m pit with 2 run-up tracks

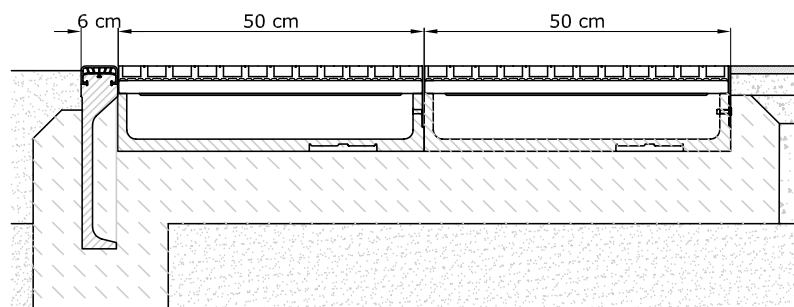
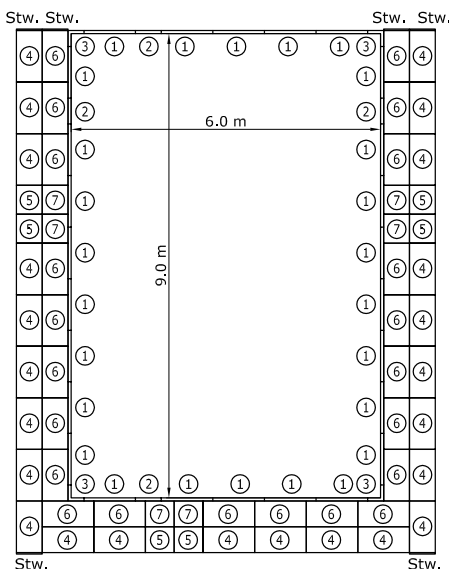

Item	Description	Art. no.	Number
1	100 x 40 x 6 cm kerbstone, white rubber	00964	26
2	50 x 40 x 6 cm kerbstone, white rubber	01572	4
3	25/25 x 40 x 6 cm angle, white rubber	00969	4
4	Outer sand capture channel 100 x 50 cm	01475	24
5	Outer sand capture channel 56 x 50 cm	01477	6
6	Inner sand capture channel 100 x 50 cm	01474	22
7	Inner sand capture channel 56 x 50 cm	01476	6
End cap	End cap for sand capture channel	15571	6

## ACO channel systems – an excellent track record in persistent heavy rain



Itaipava Arena Pernambuco in Recife, Brazil (photo: Portal da Copa/ME, www.copa2014.gov.br)

### “Drainage which stood up to the storm” during Germany's match played in continuous rain

This was especially noticeable during the 2014 World Cup at the stadium in Recife. A large ACO Monoblock channel train was installed around the pitch as a collector with an appropriate drainage capacity, and partly combined with ACO slot channels to make sure that the German national team was still able to play on suitable turf despite continuous rain. So whilst

the flooded streets outside the stadium were causing chaos, the pitch inside was still perfectly playable thanks to ACO drainage systems and components. ACO congratulated the German team, who went on to become world champions, on reaching the quarter finals.



In the stadium in Recife, Brazil:  
ACO Monoblock RD and discreet ACO slot channels in the steps right in front of the trainers' bench

**Hydraulic power calculation  
for ACO SPORT® drainage channels**

Drainage channels for sports facilities are to be measured according to DIN 18035 Part 3. The software we use for this is based on comprehensive laboratory tests conducted at the Institute of Hydraulic Engineering at Kiel University of Applied Sciences. Our hydraulic power calculations are made using differential equations to find the actual flow rate of our channels. This means any claims we make are both quick and accurate.

We can therefore provide calculations which include the particular conditions of the planned object, such as the size and structure of the drainage areas, the

rainfall intensity measurements to be considered, and the position of the channels and/or gully points. And in addition to the specific data for the channel geometry, it goes without saying that we also take the installation situation into consideration.

The actual volume of water that reaches the drain depends not only on the defined rainfall intensity measurement, but also on the surface characteristics of the areas to be drained. The applicable criteria such as seepage, evaporation and – to some extent – wetting and trough losses are taken into consideration by the flow rate.

**Flow rates according to DIN 18035 Part 3**

	Flow rate
Waterproof synthetic surface:	0.6
Permeable synthetic surface:	0.3
Lawn / artificial turf surfaces:	0.3
Cinder surfaces:	0.4

**Rainfall intensity measurement**

In accordance with DIN 18035 Part 3, rainfall with an intensity of  $r = 120 \text{ l}/(\text{s}\times\text{ha})$  should be taken as a basis. And in the absence of any special hydraulic calculations, the drainage system should be measured in accordance with DIN 18035 Part 3.

**An appropriately designed hydraulic power calculation is essential to guarantee the best possible sporting conditions**

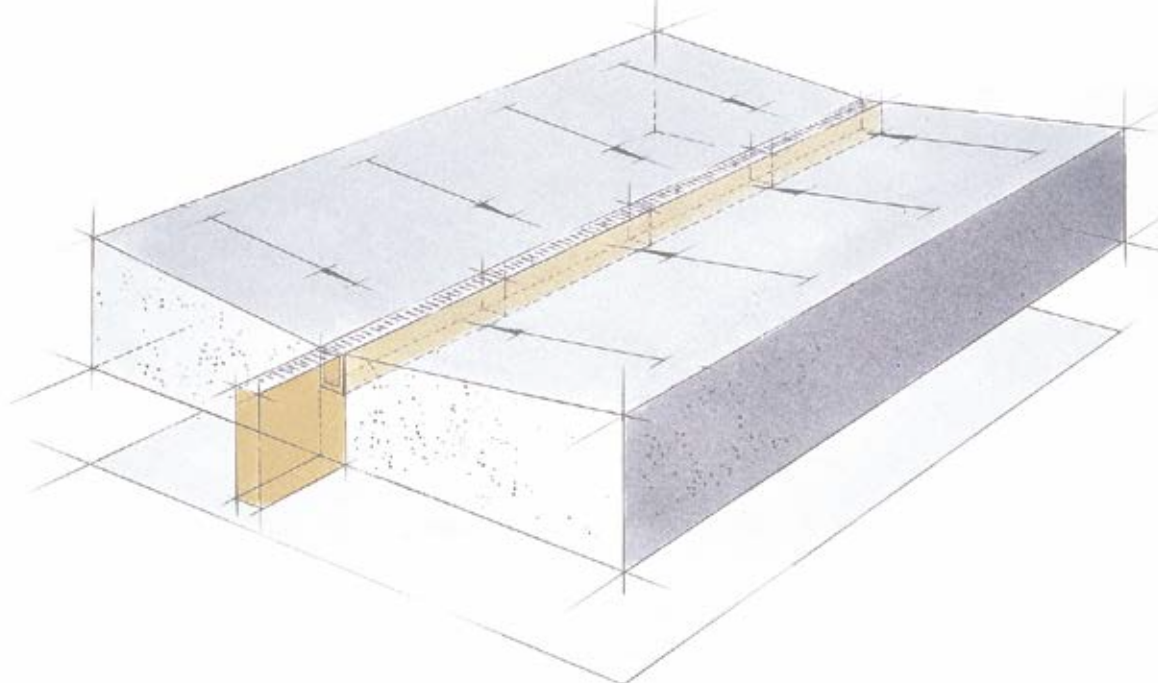





**Hydraulic measurement**

From the maximum usable space **A** calculation of **18 m<sup>2</sup>** and the rainfall intensity measurement **r** of **120 l/(s x ha)**, this produces a maximum inflow quantity **Q** of **0.216 l/s per running m** for the channel.

$$Q = A \times r \quad Q = 18 \text{ m}^2 \times \frac{120 \text{ l}}{\text{s} \times 10,000 \text{ m}^2} \quad Q = 0.216 \text{ l/s}$$

For the various flow cross-sections found in box and slot channels, the maximum gully distances are determined afterwards.

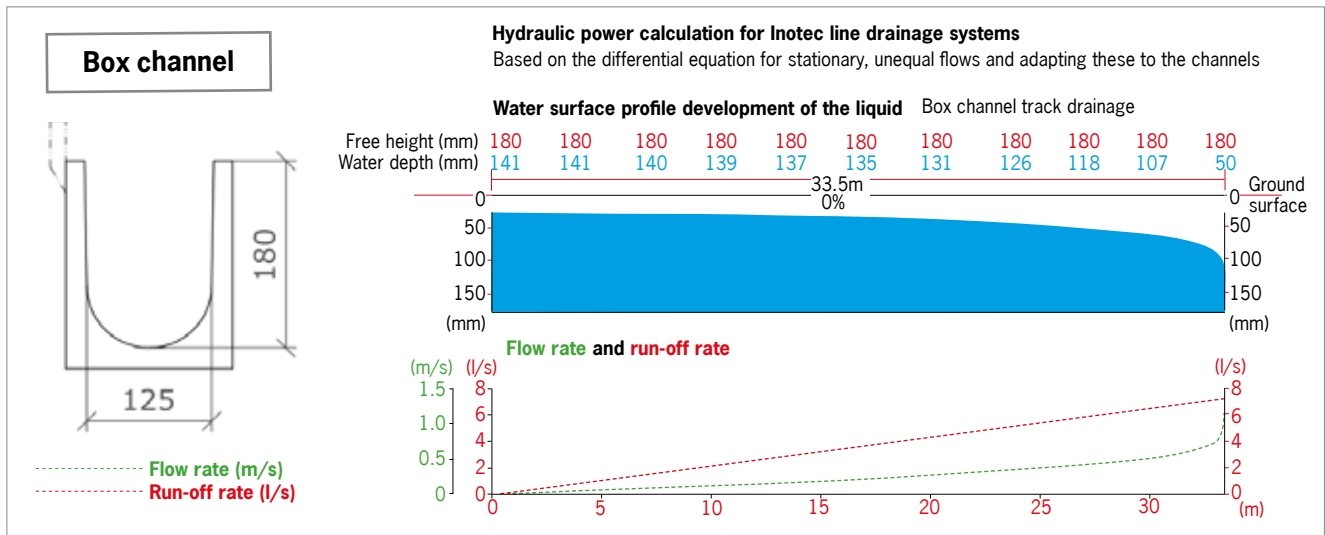

This yields an ideal utilisation of between 70 and 80% for flow lengths between 31 and 36 m. In the case of a 400 m track with equal distribution, this requires 6 inlet shafts. A distance of approx. 67 m yields 12 partial sections of approx. 33.5 m (flow direction from both sides to the inlet shaft respectively). The calculated inflow quantity of 0.216 l/s and channel length of 67 m results in a run-off rate of approx. 14.5 l/s per inlet shaft.

**Note:** The connected pipeline must be fixed in a way that means the accruing water volume can be drained without backflow. If the slot channel is used in the segments, then an additional inlet shaft is required due to the low flow cross-section in this area.

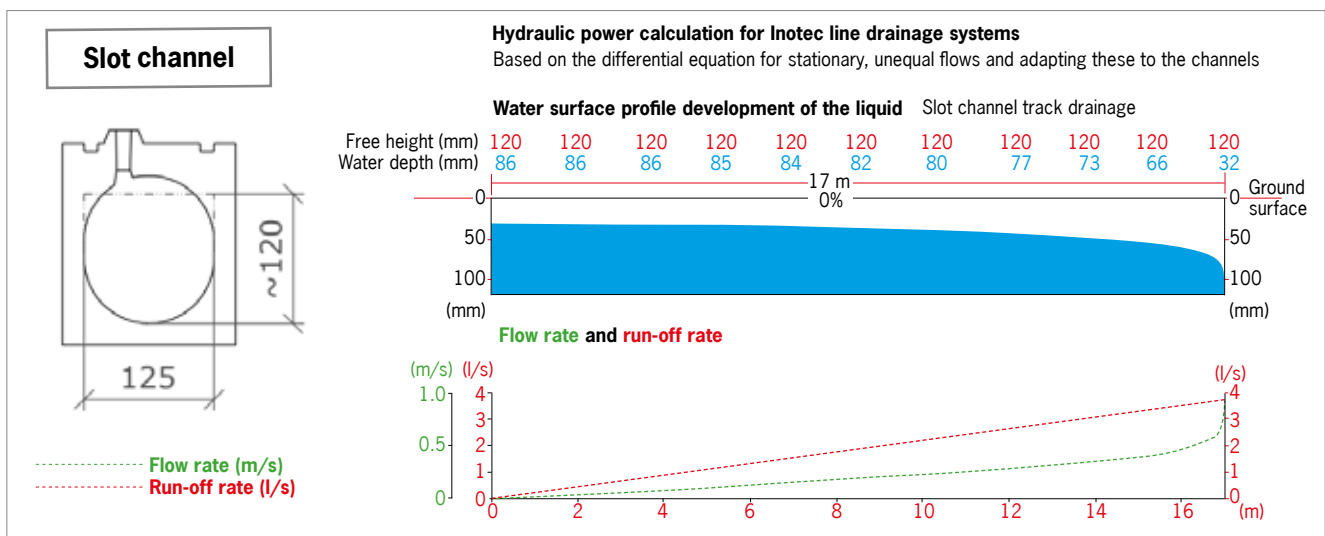

For slot channels, the optimal flow length is approx. 17 m. In the case of a 400 m track with equal distribution, this requires 12 inlet shafts. A distance of approx. 34 m yields 24 partial sections of approx. 17 m (flow direction from both sides to the inlet shaft respectively). The calculated inflow quantity of 0.216 l/s and channel length of 34 m results in a run-off rate of approx. 7.4 l/s per inlet shaft.

ACO SPORT® covered channels and hollow-profile channels offer a great deal of safety and can therefore collect and drain even greater levels of rainfall.

## Conformity and test certificates – Trust is good, but proof is better

IAAF guidelines and international competition rules go into detail regarding the structure of running tracks and playing fields, including their geometry, layout and dimensions. This also applies to individual equipment for the various athletics

disciplines. And so it is with these regulations and provisions in mind that ACO has designed and developed its drainage systems. As a result, ACO Sport covered channels and hollow-profile channels with mobile

covers are compliant with both international and national requirements. ACO SPORT® products also comply with DIN 18035 Part 3 and are CE-compliant, tested to EN 1433 standards.

conforms with IAAF and IWR regulation

**ACO Sport**  
Drainage - Systems

**ACO**

**Declaration of Conformity / Declaration de Conformité  
Konformitätserklärung / Dichiarazione di Conformità**

■ Name of company: ACO Severin Ahlmann GmbH & Co. KG  
Street: Am Ahlmannhof  
Place: D-24782 Büdelsdorf  
Country: Germany

■ declare in general responsibility, that the following Product-Systems

- ACO Sport gutter channels
- ACO Sport slotted channels with/without covers
- ACO Sport covered channels
- ACO Sport plastic covers

■ Description of the product: Drainage channels type M and covers for vehicular and pedestrian areas as well as **race-tracks** to absorb and derive surface water.

Load - capacity: A15 up to C250 under care and attention of the installation-guides  
Material channel: polymer-concrete  
Material grating/cover: 5mm thick Duroplast (GFK) GFuP (recycle-able)

■ complies with the following technical regulations and standards:

- EN 1433 08/2005 (Annex ZA)
  - Load class
  - Water tightness
  - Durability
- DIN 18035
  - Design
  - Load class
- IAAF track & field technical manual
- IWR technical manual

**Additional for the Covers:**  
- External official test to check and ensure the behaviour with strong wind loads to avoid removing of covers.

Büdelsdorf, in July 2012

*Gregor Gandach*  
Sales-Responsible,  
Gregor Gandach, Managing Director  
INOTEC Sportanlagen- und Elektroelektronik GmbH  
Am Ahlmannhof  
D-24782 Büdelsdorf

*Jan Götsch*  
Responsible,  
I.V. Jan Götsch, Head of Quality Management  
ACO Severin Ahlmann GmbH & Co. KG  
Am Ahlmannhof  
D-24782 Büdelsdorf

ACO Sport General declaration 2010

**ACO**

**Declaration of Conformity / Declaration de Conformité  
Konformitätserklärung / Dichiarazione di Conformità**

■ Name of company: ACO Severin Ahlmann GmbH & Co. KG  
Street: Am Ahlmannhof  
Place: D-24782 Büdelsdorf  
Country: Germany

■ declare in general responsibility, that the following Product-System

**ACO Sport gutter channel system**  
complies with all requirements of the Construction Products Directive (Council Directive 89/100/EEC)

■ Description of the product: Drainage channels type M for vehicular and pedestrian areas as well as race-tracks to absorb and derive surface water

Load - capacity: A15 up to C250 under care and attention of the installation-guides  
Material channel: polymer-concrete  
Material grating/cover: ---  
Nominal dimensions: L=1000mm, B=100mm, H=30mm

■ Applied harmonized standard: EN 1433 08/2005  
Conformity with: Annex ZA

■ System of conformity assessment: Council Directive 89/100/EEC Annex B, 2.01, second possibility

■ Notified body: HANSA-NORD-LABOR  
Registration No.: 0000  
Year of certification: 2012  
Certificate No.: 041 80010

■ First party control: ---

Büdelsdorf, in July 2012

*Gregor Gandach*  
Sales-Responsible,  
ACO Severin Ahlmann GmbH & Co. KG  
Am Ahlmannhof  
D-24782 Büdelsdorf

*Jan Götsch*  
Responsible,  
ACO Severin Ahlmann GmbH & Co. KG  
Am Ahlmannhof  
D-24782 Büdelsdorf

ACO Sport General declaration 2010

**ACO**

**Declaration of Conformity / Declaration de Conformité  
Konformitätserklärung / Dichiarazione di Conformità**

■ Name of company: ACO Severin Ahlmann GmbH & Co. KG  
Street: Am Ahlmannhof  
Place: D-24782 Büdelsdorf  
Country: Germany

■ declare in general responsibility, that the following Product-System

**ACO Sport covered channel system**  
complies with all requirements of the Construction Products Directive (Council Directive 89/100/EEC)

■ Description of the product: Drainage channels type M for vehicular and pedestrian areas as well as race-tracks to absorb and derive surface water

Load - capacity: A15 up to C250 under care and attention of the installation-guides  
Material channel: polymer-concrete  
Material grating/cover: 5mm thick Duroplast (GFK) GFuP (recycle-able)  
Nominal dimensions: L=1000mm, B=100mm, H=30mm

■ Applied harmonized standard: EN 1433 08/2005  
Conformity with: Annex ZA

■ System of conformity assessment: Council Directive 89/100/EEC Annex B, 2.01, second possibility

■ Notified body: HANSA-NORD-LABOR  
Registration No.: 0000  
Year of certification: 2012  
Certificate No.: 041 80010 and 041 20010

■ First party control: ---

Büdelsdorf, in July 2012

*Gregor Gandach*  
Sales-Responsible,  
ACO Severin Ahlmann GmbH & Co. KG  
Am Ahlmannhof  
D-24782 Büdelsdorf

*Jan Götsch*  
Responsible,  
ACO Severin Ahlmann GmbH & Co. KG  
Am Ahlmannhof  
D-24782 Büdelsdorf

ACO Sport General declaration 2010

**ACO**

**Declaration of Conformity / Declaration de Conformité  
Konformitätserklärung / Dichiarazione di Conformità**

■ Name of company: ACO Severin Ahlmann GmbH & Co. KG  
Street: Am Ahlmannhof  
Place: D-24782 Büdelsdorf  
Country: Germany

■ declare in general responsibility, that the following Product-System

**ACO Sport® slotted channel system**  
complies with all requirements of the Construction Products Directive (Council Directive 89/100/EEC)

■ Description of the product: Drainage channels type M for vehicular and pedestrian areas as well as race-tracks to absorb and derive surface water

Load - capacity: A15 up to C250 under care and attention of the installation-guides  
Material channel: Polymer concrete  
Material cover: 5mm thick Duroplast (GFK) GFuP (recycle-able)  
Nominal dimensions: L=1000mm, B=100mm, H=30mm

■ Applied harmonized standard: EN 1433 08/2005  
Conformity with: Annex ZA

■ System of conformity assessment: Council Directive 89/100/EEC Annex B, 2.01, second possibility

■ Notified body: HANSA-NORD-LABOR  
Registration No.: 0000  
Year of certification: 2012  
Certificate No.: 041 80010 and 041 20010

■ First party control: ---

Büdelsdorf, in July 2012

*Gregor Gandach*  
Sales-Responsible,  
ACO Severin Ahlmann GmbH & Co. KG  
Am Ahlmannhof  
D-24782 Büdelsdorf

*Jan Götsch*  
Responsible,  
ACO Severin Ahlmann GmbH & Co. KG  
Am Ahlmannhof  
D-24782 Büdelsdorf

ACO Sport General declaration 2010

Certificates available to download from [www.aco-sport.de/zertifikate](http://www.aco-sport.de/zertifikate)

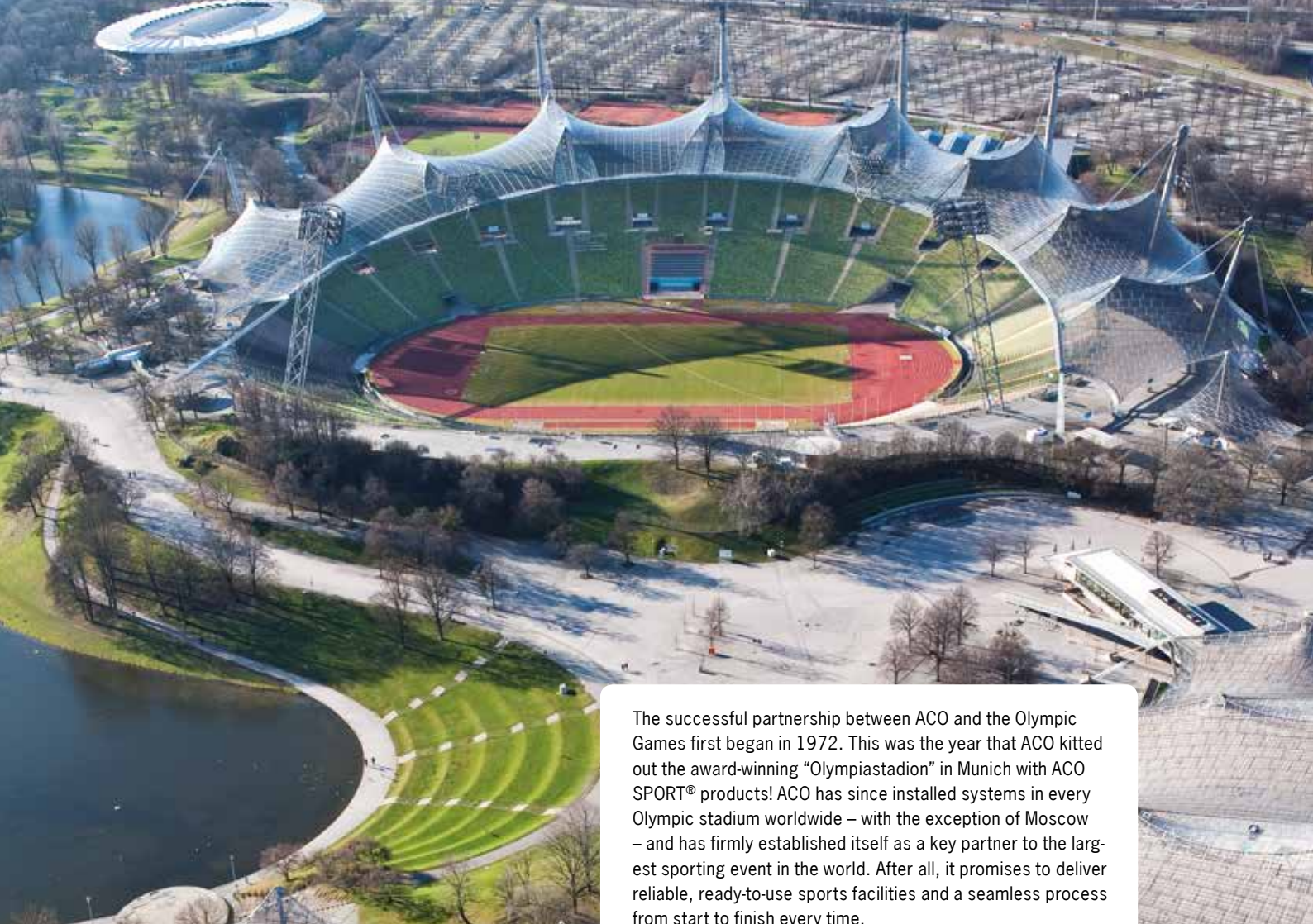

The successful partnership between ACO and the Olympic Games first began in 1972. This was the year that ACO kitted out the award-winning "Olympiastadion" in Munich with ACO SPORT® products! ACO has since installed systems in every Olympic stadium worldwide – with the exception of Moscow – and has firmly established itself as a key partner to the largest sporting event in the world. After all, it promises to deliver reliable, ready-to-use sports facilities and a seamless process from start to finish every time.



Yet another example of the company's ability to live up to its promises came at the 2014 World Cup in Brazil.



Alongside internationally acclaimed sports facilities and stadiums, thousands more regional sports centres are kitted out with ACO SPORT® products in Germany alone.

**ACO Severin Ahlmann  
GmbH & Co. KG**

P. O. Box 320, 24755 Rendsburg  
Am Ahlmannkai, 24782 Büdelsdorf  
Germany  
Phone +49 4331 354-0  
Fax +49 4331 354-223  
info@aco-international.com  
**www.aco.com**