

Uniclass L7315	EPIC J3413
CI/SfB (52.5)	

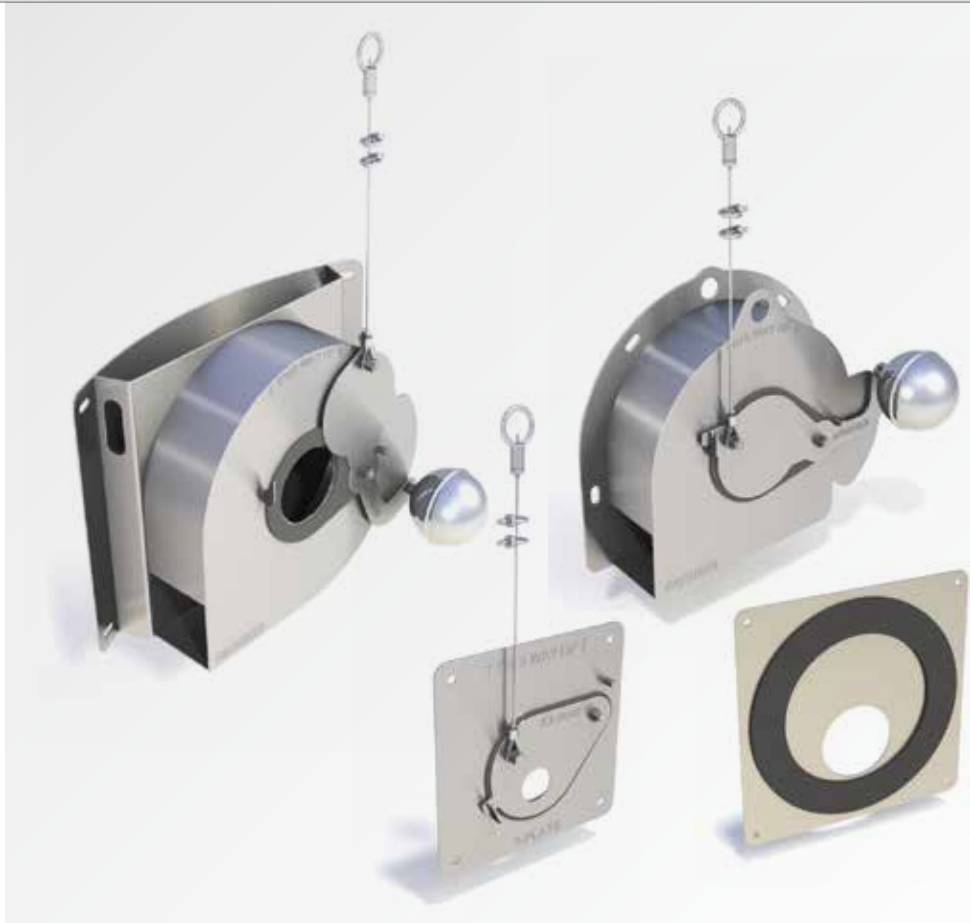

Surface Water Flow Control Systems

ACO Q-Brake Vortex and ACO Q-Plate



Introduction to the ACO Group

Throughout the world ACO branded drainage and surface water management systems are recognised for their innovative design, high quality manufacture, environmental excellence and industry leading performance.

Today the ACO Group has a research and production base that reaches across four continents. This unmatched resource pioneers the development of solutions that are tailored to individual applications, meeting the need for high performance, sustainable products that deliver optimum value throughout their operational life.

ACO Technologies plc

ACO operates as ACO Technologies plc in the United Kingdom. Founded over 25 years ago, the company has grown quickly on a reputation for design innovation and customer service.

There are 2 core divisions, ACO Water Management and ACO Building Drainage, that serve every sector of the construction industry, providing solutions for applications as diverse as rail, highways, airports, landscaping, retail, distribution centres and environmentally sensitive projects.



To help architects, designers and contractors meet the legal requirements that now tightly control the way surface water is managed, ACO has created its unique 'Surface Water Management Cycle' – Collect, Clean, Hold, Release – the four core processes now required for the complete and sustainable management of surface water drainage.



Contents

Introduction to ACO's surface water control systems	4
Benefits of using a surface water control system	6
<hr/>	
ACO Q-Brake Vortex features overview	8
ACO Q-Brake Vortex specification and design process	10
ACO Q-Brake Vortex Installation detail	11
Operation and maintenance recommendations	12
<hr/>	
Introduction to ACO Q-Plate	14



Introduction to ACO's Surface Water Flow Control Systems

ACO's range of flow control systems are designed to regulate storm water flow before it discharges into the watercourse or sewer networks. ACO Q-Brake Vortex flow controls and ACO Q-Plate orifice plates are capable of regulating any flow for surface water applications and can be used in conjunction with retention and attenuation systems, such as ACO StormBrixx, as an integrated sustainable urban drainage (SuDS) scheme.

What is a Q-Brake section?

ACO Q-Brake Vortex is a horizontal vortex flow control designed to regulate storm water flows from 2-100 litres per second. Manufactured from grade 304 stainless steel, each ACO Q-Brake Vortex is individually configured to suit specific performance criteria.

The design of a vortex flow control is based on the fluid mechanics principle of the forced vortex, which permits flow regulation without any moving parts.

ACO Q-Brake Vortex utilises the upstream head and discharge to generate a 'vortex' within the structure of the unit. The water is then released at a pre-determined controlled rate preventing downstream flooding.

Unlike more conventional methods, ACO Q-Brake Vortex is less prone to blockage, and permits higher flow at a lower head of water, as a vortex control allows an outlet 4-6 times larger in cross sectional area to be used.

ACO Q-Brake Vortex can form part of the design of any integrated drainage scheme for a wide range of infrastructure, industrial and other SuDS applications.



What is ACO Q-Plate?

ACO Q-Plate orifice plates are designed for use where an ACO Q-Brake vortex is not the most effective solution.

To suit application requirements, the range is available with or without remote bypass and drain down and is designed to match a variety of manhole configurations.

Information regarding the specification of ACO Q-Plates can be found on page 14.

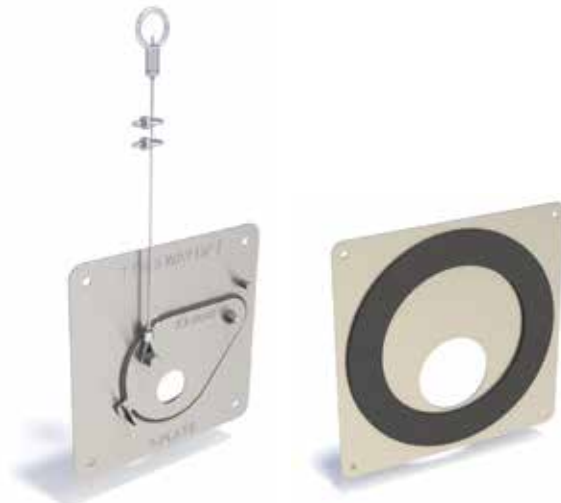

ACO Q-Plates with and without draindown

Why choose ACO Q-Brake Vortex?



▶ Planning and connection

ACO Q-Brake Vortex addresses the planning and connection requirements set out in the Floods and Water Management Act. Where a discharge restriction is in place, ACO Q-Brake Vortex regulates the surface water flow to the specified rate.

▶ Tailored performance

Each ACO Q-Brake Vortex is tailored to the specific performance requirements of the application providing optimum efficiency within the system.

▶ Optimum hydraulic efficiency

The mechanism employed within ACO Q-Brake Vortex provides superior hydraulic performance in comparison to traditional flow control systems.

▶ Water Authority Approval

ACO Q-Brake Vortex has been approved for use by a number of water authorities including Severn Trent, Anglian and Scottish Water.

▶ Proven performance

ACO Q-Brake Vortex is UK manufactured and has been independently laboratory tested to verified discharge rates.

▶ Simplified access and maintenance

ACO Q-Brake Vortex has large clear openings making it less prone to blockage. The absence of any loose parts also reduces maintenance requirements.

The patented bypass door and emergency drain down facility allows ACO Q-Brake Vortex to be remotely accessed from the surface to allow the upstream system to be independently drained, completely bypassing the inlet. Building Regulations 2000 Section H discourages direct man access to sewer manholes.

▶ Reduces total installed cost

ACO Q-Brake Vortex allows more flow at lower heads, reducing the need for on-site storage volume requirements and lowering installation costs.

▶ Ease of installation

Each ACO Q-Brake Vortex unit is custom built to suit the profile of the chamber. Radius fixing options remove the need for additional benching - simplifying installation and reducing cost.

▶ MicroDrainage

ACO Q-Brake Vortex can be sized and modelled on the latest version of the design software and can be incorporated into the overall hydraulic drainage design.

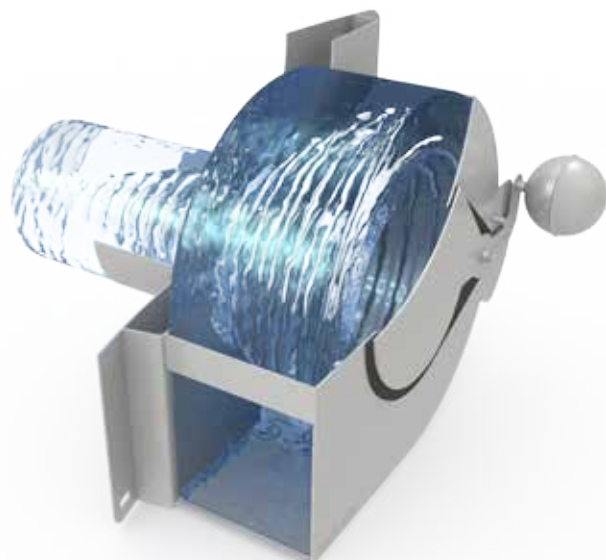

Benefits of using a surface water flow control system

Storage and the controlled release of clean water into the natural environment is an important aspect of managing surface water in the SuDS approach. The Floods and Water Management Act now gives overall responsibility to the local regulatory body to impose, where appropriate, the discharge rate of a surface water flow control system.

ACO's range of flow control systems can be used in conjunction with ACO's award-winning attenuation and infiltration system, ACO StormBrixx, to provide a fully integrated storm water control system meeting the requirements of the regulations.

This diagram simulates how the ACO StormBrixx system is used to provide storm water attenuation, whilst the ACO Q-Brake Vortex is used to regulate the rate of discharge from the development into the watercourse or sewer network.

Compared to the use of traditional flow control systems, the combination of ACO StormBrixx and ACO Q-Brake Vortex can reduce the need for additional upstream storage lowering overall installation and maintenance costs.

This benefit is best demonstrated in the example opposite. The conclusion of the example means that upstream storage can be reduced by 11m^3 compared to using a traditional flow control system.

Example:

There is a project in Bedford, England with a catchment area of $13,000\text{m}^2$. The project has design criteria of a 1 in 30 year storm and the runoff from the site must not exceed 6.3l/s at a design head of 1.3m .

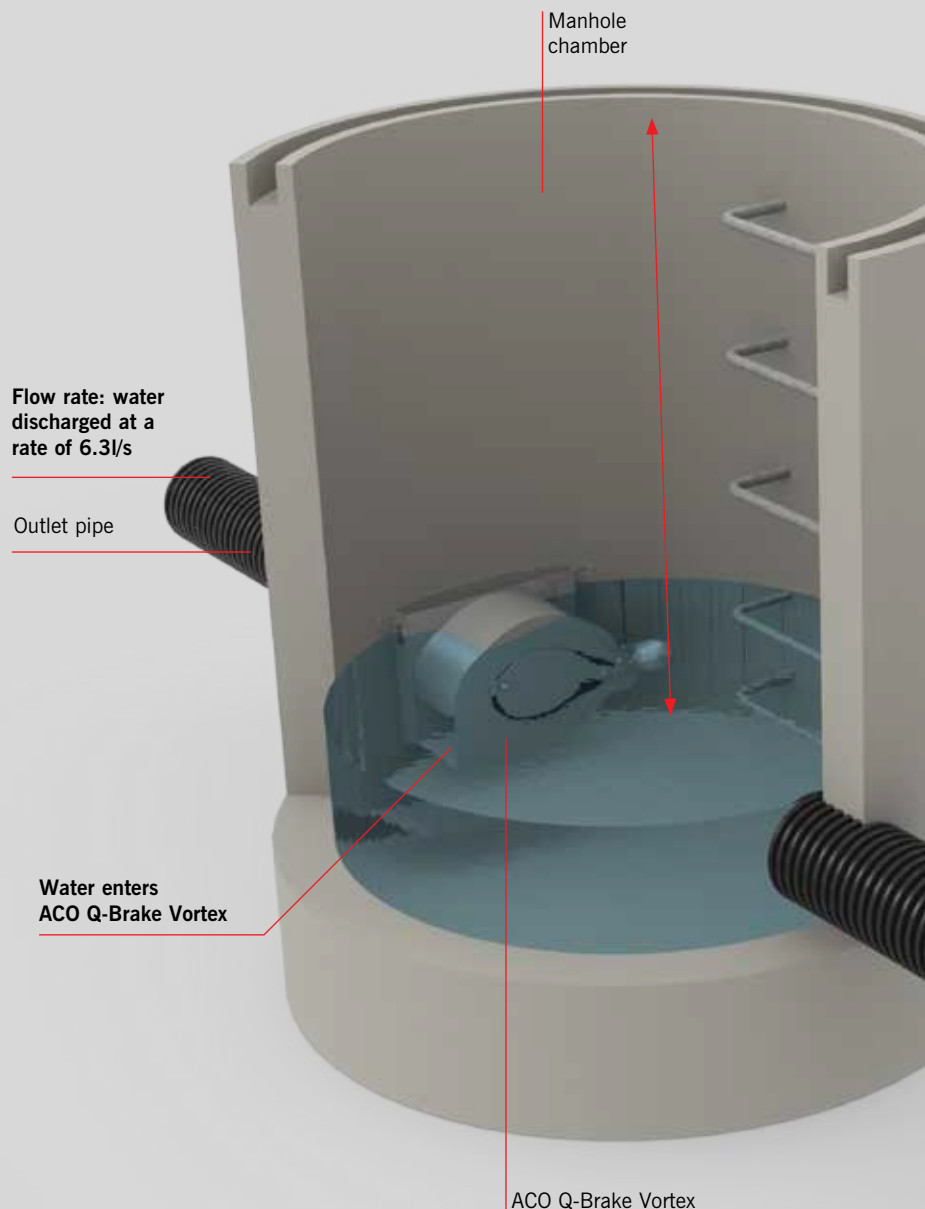

For more information on ACO's award winning attenuation and infiltration system, ACO StormBrixx, please go to www.aco.co.uk.

Results:

Using MicroDrainage® software, ACO has compared the upstream storage requirements using ACO Q-Brake Vortex and a traditional orifice plate. The results are summarised below:

- ▶ ACO Q-Brake Vortex required $\varnothing 90\text{mm}$. Upstream attenuation required 402m^3 .
- ▶ Orifice plate size required $\varnothing 51\text{mm}$. Upstream attenuation required 413m^3 . ACO Q-Brake Vortex reduces upstream attenuation by 11m^3 whilst having an orifice over three times the area of the traditional orifice plate and making ACO Q-Brake Vortex more efficient and far less prone to blockage.

Discharge characteristics

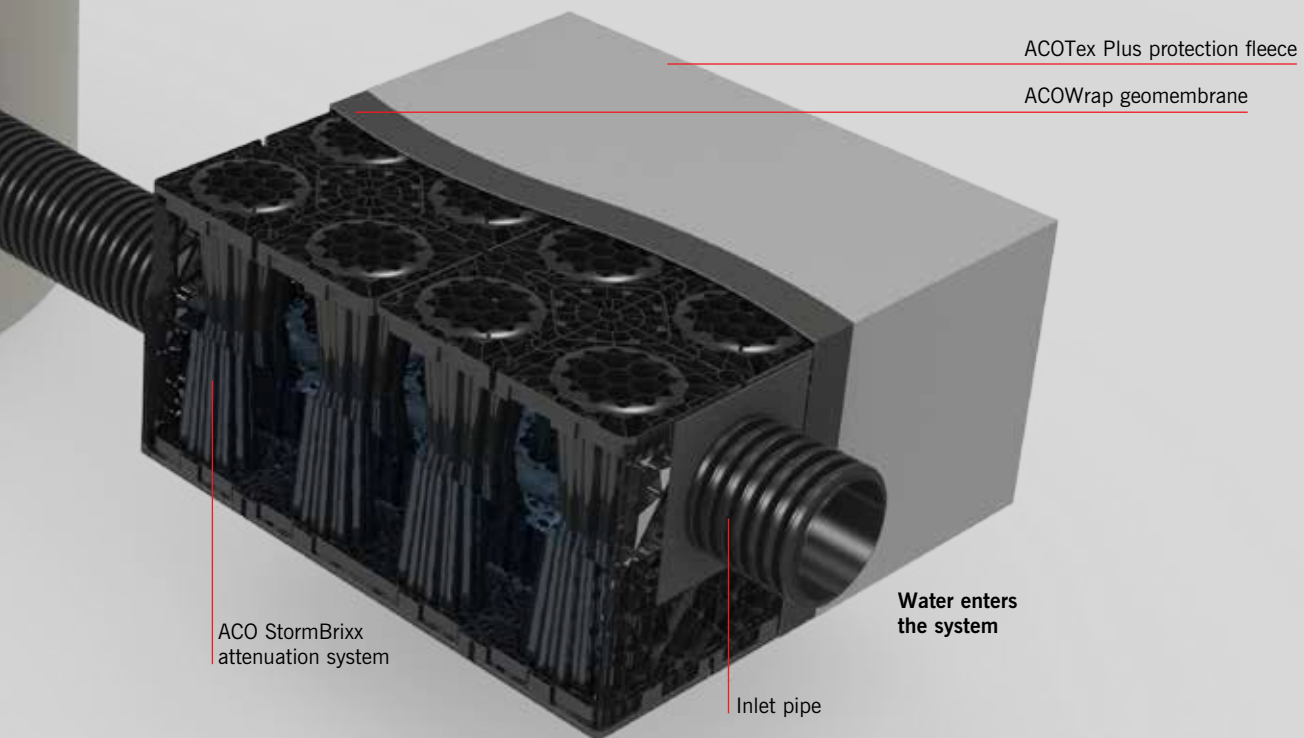
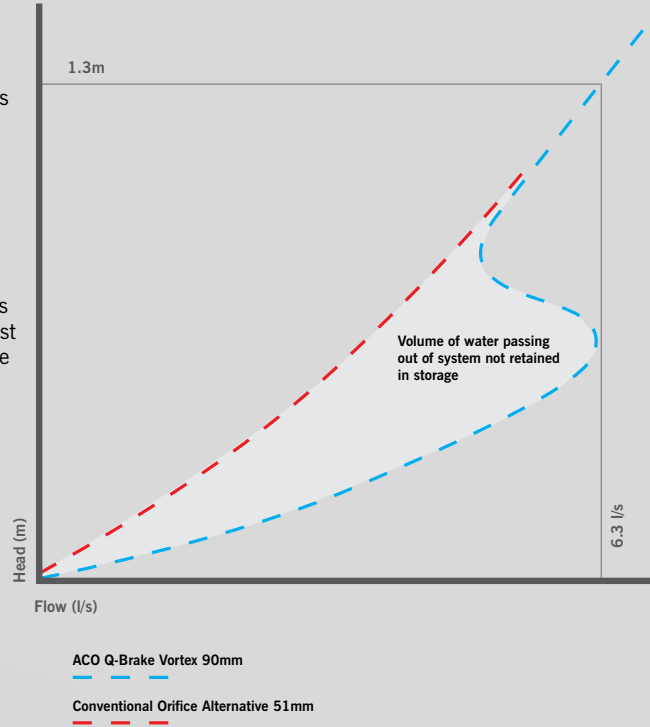

ACO Q-BRAKE FLOW CONTROL FEATURES OVERVIEW

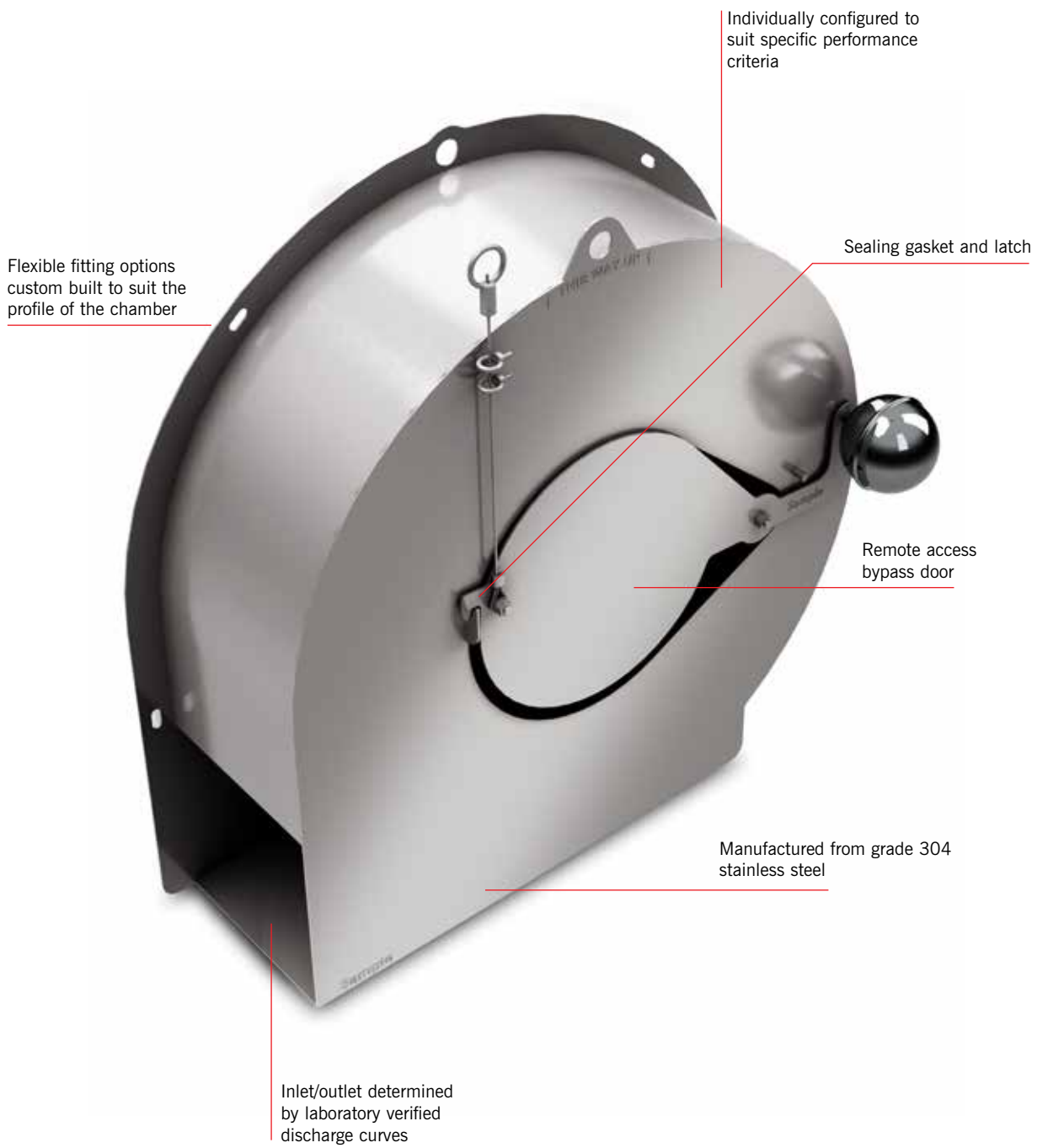

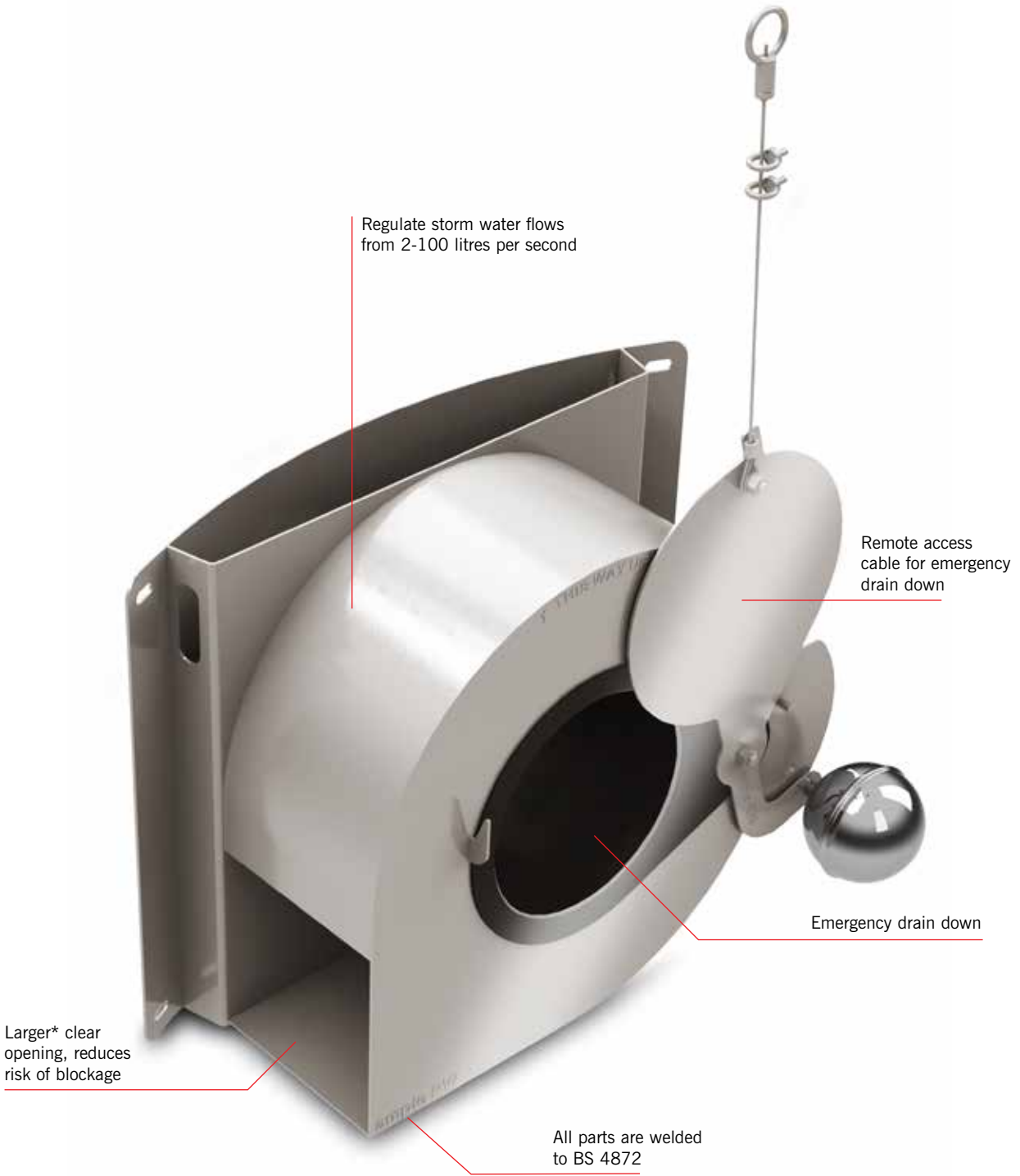

ACO Q-Brake Vortex specification and design process

Manufactured from grade 304 stainless steel, each ACO Q-Brake Vortex is individually configured to suit specific performance criteria. Our engineers will use industry standard drainage software and hydraulic design calculations to ensure the system is correctly sized for any project requirement.

In order to complete this process and deliver the product options available, please provide the ACO engineers with the following information:

- ▶ The proposed design flow – maximum allowable discharge
- ▶ The proposed design head – invert of outlet pipe to top water level
- ▶ The proposed outlet pipe diameter
- ▶ The proposed type and size of outlet manhole

Before production can commence, ALL of the above information must be verified on ACO's Contract Review Document issued at the time of order placement.

Finished product

From this information ACO will size and design the ACO Q-Brake Vortex to meet the design criteria and to suit the proposed surface water application.

ACO will supply:

- ▶ Head discharge table & graph
- ▶ ACO Q-Brake Vortex installation details
- ▶ Information for manhole sizing

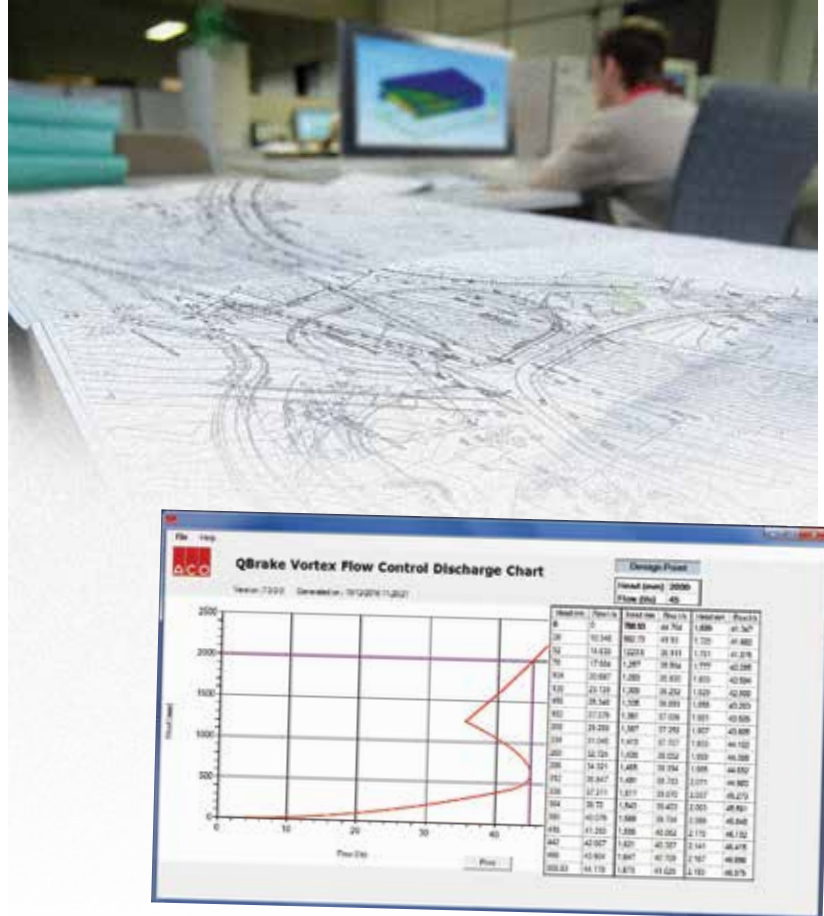

ACO Water Management Design Services Team

ACO has embraced the concept of 'value engineering' – a totally new approach to on-site construction that saves both time and money. ACO will review any design to minimise the total scheme and life cost of a proposal.

By utilising ACO's portfolio of products, it is often possible to remove the need for conventional underground drainage.

ACO Water Management Design Services Team

Tel: 01462 816666
Email: technical@aco.co.uk



Micro Drainage Modelling

ACO Q-Brake Vortex can be sized and modelled on the latest version of Micro Drainage.



Installation detail

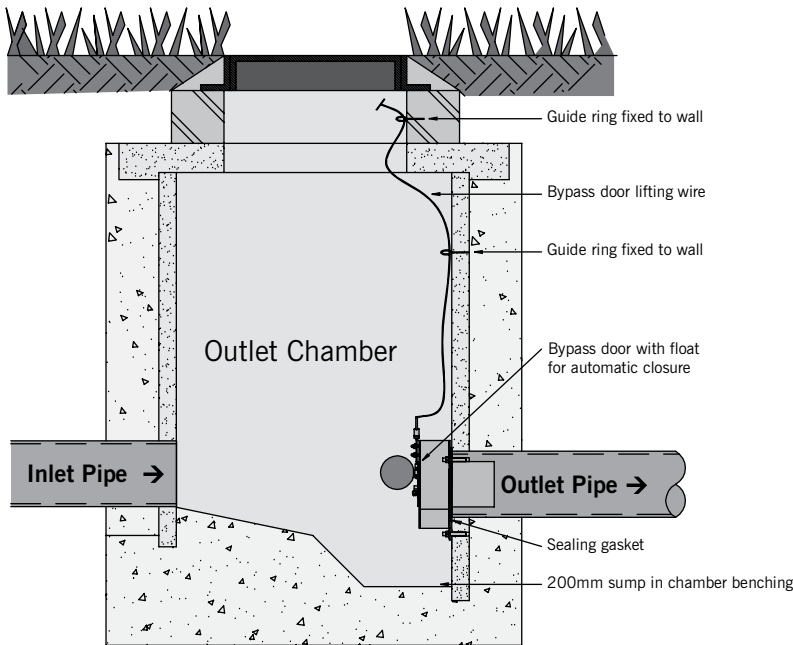

Fixing installation detail for round manhole chambers

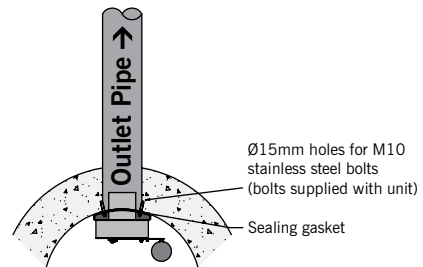

Fixing installation detail for flat sided manhole chambers

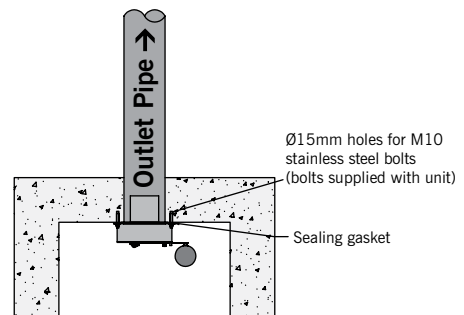

Guide to installing ACO Q-Brake Vortex flow control regulator

Step 1:

Construct the chamber that is to house the ACO Q-Brake Vortex flow control. Note that if the chamber has a curved wall (e.g. a concrete ring manhole), the diameter of the chamber should be specified on the order and Contract Review Document for the ACO Q-Brake Vortex flow control unit.

Step 2:

The base of the chamber must be at a level 200mm below the bottom of the ACO Q-Brake Vortex flow control. When the chamber base is benched, there must be a 200mm deep sump below the bottom of the unit as shown on the sketch.

Step 3:

Offer the ACO Q-Brake Vortex flow control unit up to the outlet pipe using the lifting eyes where appropriate. Ensure the unit is upright (arrow pointing vertically up). Mark the position of the fixing holes on the chamber wall. Remove the unit and drill fixing holes to suit the M10 bolts supplied with the unit. (Note bolts are Rawlbolt R-XPT-S stainless steel M10 bolts requiring a hole 15mm diameter).

Step 4:

Place bolts into the drilled holes. Locate the ACO Q-Brake Vortex flow control onto the bolts (again check it is upright). Ensure that the gasket is flat against the wall. Fit the nuts and tighten them to pull the unit against the gasket and seal it against the wall.

Step 5:

Fix the two wire guide rings (supplied) to the chamber wall, one approx mid height and one just under the access cover. Thread the bypass door lifting wire through the rings. Adjust the length of the wire by fixing the handle in the correct position and cut to length if necessary.



An electronic version of the ACO Q-Brake Vortex installation detail is available to download from the ACO website. Visit www.aco.co.uk.



Operation and maintenance recommendations

Commissioning the product

Before the product is commissioned, the chamber containing the ACO Q-Brake Vortex should be inspected in line with normal practice. Any debris or silt should be removed. Any visible fixing bolts should be checked.

If an internal blockage is suspected, the control can be inspected internally and cleaned out by opening the inspection bypass door on the upstream end. The bypass door must be returned to the closed position before the control becomes operational or bolted shut.

Frequency of inspection / maintenance

Inspections should be carried out at frequent and regular intervals (approximately every 3-6 months). The frequency will depend upon the location and the environment, and should be based on local knowledge. Action is only required in the event of a blockage or suspected blockage.

Maintenance plan

ACO Q-Brake Vortex flow controls require no routine maintenance although inspections should be carried out at regular intervals (See frequency of inspection / maintenance section).

Manual handling

ACO Q-Brake Vortex flow controls should be handled in accordance with current legislation and regulations:

- The Health and Safety at Work Act 1974
- The Management of Health and Safety at Work Regulations 1999
- The Manual Handling Operations Regulations 1992

Service life

ACO Q-Brake Vortex flow controls have no moving parts to wear or fail. Manufactured from grade 304 stainless steel plate they will resist scour, degradation and chemical attack. The unit is designed to easily outlast the drainage system in which it is installed.

COSHH

ACO Q-Brake Vortex flow controls are manufactured from grade 304 stainless steel. This material is not regarded as hazardous to health and demonstrates no chemical hazard when used for the stated applications.

MODEL SPECIFICATION CLAUSE

The vortex flow control device shall be supplied by ACO Technologies plc; all materials and components within the scope of this system shall be obtained from this manufacturer.

All units shall be manufactured from grade 304 stainless steel incorporating rear mounted remote access bypass and emergency drain down door complete with stainless steel cable and fixings.

ACO Q-Brake Vortex is a vortex flow control device designed to suit a design head of #mm and design flow of # litres per second.

Insert information as appropriate

NBS Specification

ACO Q-Brake Vortex should be specified in section R12. Assistance in completing this clause can be found in the ACO Water Management entry in NBS Plus, or please contact the ACO Water Management Design Services Team.

Note: A specification in NBS format is available to download from www.thenbs.com or www.aco.co.uk

RECYCLED CONTENT

ACO Technologies aims to incorporate as much recycled material or waste material as is practicable in its manufactured products.



Typically steel products contain between 25% and 33% recycled content by weight. Therefore the total recycled content of the ACO Brake Vortex will contain be at minimum approximately 25% by weight recycled material.

ACO Q-Brake Vortex is intended for a long life with low maintenance, to reduce the need to recycle, but when eventually the product is no longer needed, much of its content can be readily recycled with a very low risk of pollution to the environment.





Product Testing

Through ACO's continual product development and refinement programme has led to an enhanced range of ACO Q-Brake Vortex flow controls. The range has been independently tested and complex software written to ensure that the best possible characteristics and curves are achieved to help reduce upstream storage requirements and installation costs.



What is ACO Q-Plate?

ACO Q-Plate orifice plates are designed for use where an ACO Q-Brake vortex is not the most effective solution. To suit application requirements, the range is available with or without remote bypass and drain down and is designed to match a variety of manhole configurations. A neoprene sealing gasket and fixing holes are featured on each unit.



ACO Q-Plate with remote draindown and bypass recommended for all orifice apertures less than 100mm

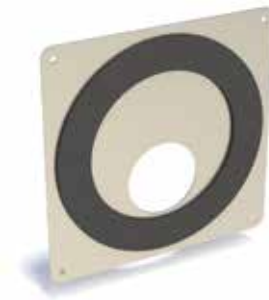

ACO Q-Plate



ACO Q-Plate Bypass features

- ▶ Manufactured from 304 stainless steel
- ▶ Orifice aperture up to 150mm
- ▶ Sealing pipe gasket
- ▶ Emergency drain-down and access cable
- ▶ Bypass door (with improved seal) and latch
- ▶ Flat or curved radius to suit manhole diameter
- ▶ Manhole fixings

ACO Q-Plate features

- ▶ Manufactured from 304 stainless steel
- ▶ Four fixing positions
- ▶ Pipe sealing gasket
- ▶ Manhole fixings
- ▶ Flat or curved radius to suit manhole diameter

ACO Q-Plate Specification and design process

To suit project requirements, two options of ACO Q-plate are available:

ACO Q-Plate Bypass

< 100mm orifice with remote drain-down and bypass (also available up to 150mm)

ACO Q-Plate

> 100mm orifice without remote drain-down and bypass

In order to complete this process and deliver the product options available, please provide the ACO engineers with the following information:

- ▶ The proposed design flow – maximum allowable discharge
- ▶ The proposed design head – invert of outlet pipe to top water level
- ▶ The proposed outlet pipe diameter
- ▶ The proposed type and size of outlet manhole

Before production can commence, ALL of the above information must be verified on ACO's Contract Review Document issued at the time of order placement.

Finished product

From this information ACO will size and design the ACO Q-Plate to meet the design criteria and to suit the proposed surface water application.

ACO will supply:

- ▶ Head discharge table & graph
- ▶ ACO Q-Plate installation details
- ▶ Information for manhole sizing

Guide to installing an ACO Q-Plate

Step 1:

Construct the chamber that is to house the ACO Q-Plate orifice control. Note that if the chamber has a curved wall (e.g. a concrete ring manhole), the diameter of the chamber should be specified on the order and Contract Review Document for the ACO Q-Plate Orifice control unit.

Step 2:

There should be a small sump under the outlet to ensure the orifice control does not easily block, ideally there should be upstream sediment and debris traps. When the chamber base is benched, there should be a minimum 200mm deep sump below the bottom of the unit as shown on the sketch.

Step 3:

Offer the ACO Q-Plate orifice control unit up to the outlet pipe. Ensure the unit is upright (arrow pointing vertically up) and that the orifice is correctly positioned at the invert of the outlet pipe.

Check there is a good seal between the orifice plate and the outlet pipe. Mark the position of the fixing holes on the chamber wall. Remove the unit and drill fixing holes to suit the bolts supplied with the unit.

Step 4:

Place bolts into the drilled holes. Locate the ACO Q-Plate orifice control onto the bolts (again check it is correctly aligned). Ensure that the gasket is flat against the wall. Fit the nuts and tighten them to pull the unit against the gasket and seal it against the wall.

Step 5:

If you have been supplied the Q-Plate with the drain down and bypass door fix the two wire guide rings (supplied) to the chamber wall, one approx mid height and one just under the access cover.

Thread the bypass door lifting wire through the rings. Adjust the length of the wire by fixing the handle in the correct position and cut to length if necessary.

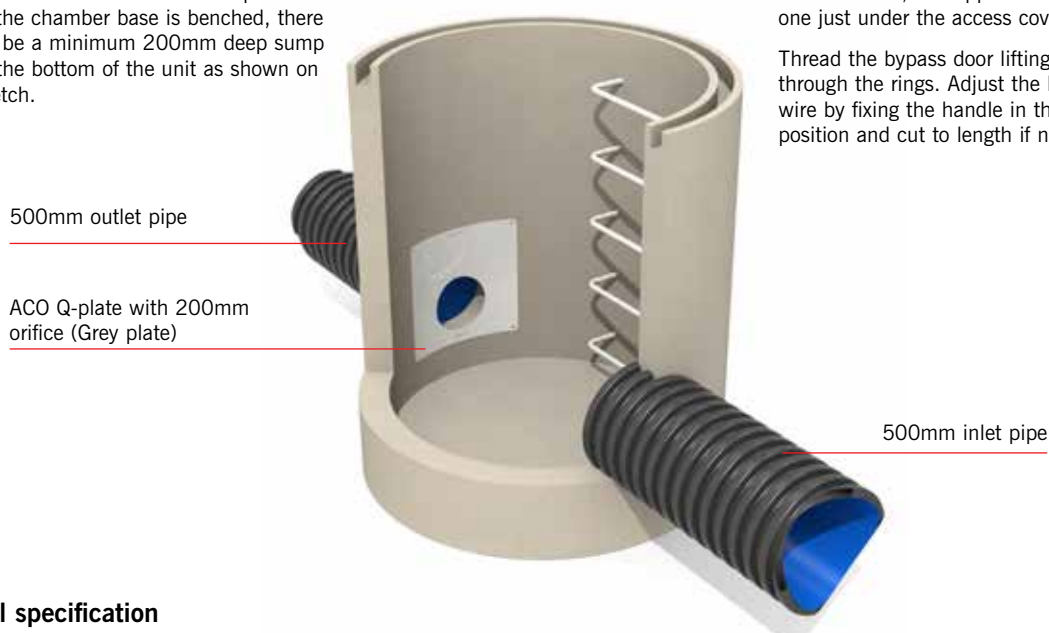

Model specification

ACO Q-Plate orifice control *with remote drain down and bypass (delete as appropriate), ##mm orifice designed to suit a pipe outlet size of ###mm, a design head of ## mm and design flow of # litres per second.

#insert information as appropriate.



ACO Technologies plc

- ACO Water Management
Civils + Infrastructure
Building + Landscape
- ACO Building Drainage
- ACO Sport
- ACO Wildlife



ISO 9001
FM 13502



ISO 14001
EMS 538781



OHSAS 18001
OHS 524145

ACO Water Management

A division of ACO Technologies plc
ACO Business Park,
Hitchin Road,
Shefford,
Bedfordshire
SG17 5TE

Tel: 01462 816666

Fax: 01462 815895

e-mail Enquiries: awmenquiries@aco.co.uk

e-mail Sales: customersupport@aco.co.uk

e-mail Technical: technical@aco.co.uk

website: www.aco.co.uk

The ACO Group: A strong family you can depend on.

© May 2017 ACO Technologies plc. All reasonable care has been taken in compiling the information in this document. All recommendations and suggestions on the use of ACO products are made without guarantee since the conditions of use are beyond the control of the Company. It is the customer's responsibility to ensure that each product is fit for its intended purpose, and that the actual conditions of use are suitable. This brochure and any advice is provided by ACO Technologies plc (the Company) free of charge and accordingly on terms that no liability including liability for negligence will attach to the Company or its servants or agents arising out of or in connection with or in relation to this brochure or any such advice. Any goods supplied by the Company will be supplied solely upon its standard conditions of sale, copies of which are available on request. The Company's policy of continuous product development and improvement renders specifications liable to modification. Information provided in this brochure is therefore subject to change without prior notification.

ACO CARES ABOUT THE ENVIRONMENT

Printed on material certificated in accordance with the rules of the FSC who provide a means of assuring that products come from responsibly managed forest.